



reditelsa

Redes y Equipos de Telecomunicaciones, S.A.L.

C/Cercedilla 8, Nave 42. Pol. Ind. Ventorro del Cano.

28925 Alcorcón – Madrid

Tlf: +34.91.633.75.07

Fax: +34.91.632.58.21

info@reditelsa.com

www.reditelsa.com

Realización de cableado a medida.

Ponemos a su disposición la fabricación de cualquier tipo de cableado, en una gran variedad de conectores y longitudes, bajo prescripción del cliente. Todo ello realizado con la última tecnología.



CABLEADO ESTRUCTURADO

5

• Paneles de parcheo.....	6
• Módulos y conectores.....	8
• Latiguillos.....	10
• Cable de pares.....	12
• Adaptadores/Rosetas.....	13
• Accesorios.....	14
• ISDN y Sistema 110.....	16

HERRAMIENTAS, TÉSTER Y CERTIFICADORES

17

• Téster, certificadores y crimpadoras.....	18
• Pelacables.....	19
• Alicates y extractores.....	20
• Impactadoras.....	21
• Herramientas network.....	22

I.C.T. Y TELEFONÍA

23

• Telefonía.....	24
• Cajas de registro / Regletas de corte y prueba.....	25
• Accesorios.....	26

RACKS Y ACCESORIOS

27

• Murales serie RME.....	28
• Murales serie RM1.....	30
• Murales serie RM2.....	32
• Racks serie RC.....	34
• Racks serie RCE.....	36
• Bastidores laboratotio.....	38
• Cold Pool System for Data Center.....	39
• Racks protección electromagnética.....	40
• Mural 1 cuerpo / Mini mural 10".....	41
• Regletas para rack.....	42
• Accesorios para rack.....	44

• Latiguillos multimodo 62.5/125 OM1-Dúplex.....	48
• Latiguillos multimodo 50/125 OM2-Dúplex.....	49
• Latiguillos multimodo 50/125 OM3-Dúplex.....	50
• Latiguillos multimodo 50/125 OM4-Dúplex.....	51
• Latiguillos monomodo 9/125 OS2 Simplex/Dúplex.....	52
• Pig Tails.....	53
• Conectores / Atenuadores.....	54
• Adaptadores.....	55
• Accesorios.....	56

• Cables USB 2.0.....	60
• Cables USB 3.0.....	62
• Cables extensores USB 2.0 / 3.0.....	63
• Adaptadores / Cables Sub D.....	64
• Adaptadores USB.....	65
• Componentes USB.....	66

• Cables HDMI.....	68
• Adaptadores HDMI.....	69
• DisplayPort / VGA / DVI.....	70

• Serie BNC.....	72
• Serie N.....	74
• Serie TNC / Serie 7/16.....	75
• Serie 1.6/5.6.....	76
• Serie 1.0/2.3.....	78
• Serie SMB / Serie SMZ.....	79
• Serie F / Serie FME / Serie PL/UHF.....	80
• Serie SMA.....	81
• Serie Balun.....	82

• Carcasas Sub D.....	84
• Conectores Sub D.....	85
• Cables cinta plana.....	87
• Otros conectores.....	89
• Cables de red.....	90
• Clavijas de red.....	92

Cableado Estructurado

The background features a large, light green, stylized letter 'A' shape. To the left, a series of thin green lines converge towards a central point and then fan out towards the right. At the bottom, there are several curved, overlapping green bands of varying shades, creating a sense of depth and movement. The overall aesthetic is clean, modern, and technical.

PANELES DE PARCHEO



Paneles de parcheo modulares 19"

- PA16P** Panel modular 16 huecos 19" 1U
- PA37576** Panel modular 16 huecos 19" 1U acero inoxidable
- PA37580/E** Panel modular 24 huecos 19" 1U
- PA37571** Panel modular 24 huecos 19" 1U acero inoxidable

Paneles de parcheo modulares 19"

- PA37580/EU** Panel modular 24 huecos 19" 1U
- PA37580/EG** Panel modular 24 huecos con guardapolvo 19" 1U
- PA375705** Panel 24 puertos 19" 1/2U vacío

Paneles de parcheo 10"

- PA12F5E** Panel FTP Cat.5e 12 puertos 10" 1U LSA 100 MHz
- PA12F6** Panel FTP Cat.6 12 puertos 10" 1U LSA 250 MHz
- PA12U6** Panel UTP Cat.6 12 puertos 10" 1U LSA 250 MHz
- PA12U5ELCI** Panel UTP Cat.5e 12 puertos 10" 1U LCI 100 MHz
- PA12U6LCI** Panel UTP Cat.6 12 puertos 10" 1U LCI 250 MHz

nuevo



Paneles modulares doble hembra

- PA24DH6** Panel modular H/H UTP Cat.6 24 puertos 19" 1U 250 MHz
- PA24DH6F** Panel modular H/H FTP Cat.6 24 puertos 19" 1U 250 MHz
- PA37598** Panel modular H/H FTP Cat.6A 24 puertos 19" 1U 500 MHz
- PA37599** Panel modular H/H FTP Cat.6A 48 puertos 19" 1U 500 MHz

Paneles de parcheo 19" UTP 110/AMP

- PA24U5EM** Panel UTP Cat.5e 24 puertos 19" 1U 110 100 MHz
- PA24U6M** Panel UTP Cat.6 24 puertos 19" 1U 110 250 MHz
- PA24U5EX2** Panel UTP Cat.5e 24 puertos 19" 1U AMP 100 MHz
- PA24U6X2** Panel UTP Cat.6 24 puertos 19" 1U AMP 250 MHz

Paneles de parcheo 19" UTP LSA

- PA37584/E** Panel UTP Cat.5e 24 puertos 19" 1U LSA 100 MHz
- PA37585/E** Panel UTP Cat.6 24 puertos 19" 1U LSA 250 MHz
- PA48U5E** Panel UTP Cat.5e 48 puertos 19" 2U LSA 100 MHz
- PA48U6** Panel UTP Cat.6 48 puertos 19" 2U LSA 250 MHz



nuevo



IDEAL
technologies



Panel de parcheo 10" vacío

- PA12** Panel 12 puertos 10" 1U vacío

Nuevo panel de parcheo mural 10"

- PA12U6EM** Panel UTP Cat.6 12 puertos 10" 1U mural

Panel modular angulado 19"

- PA37592** Panel modular angulado 24 huecos 19" 1U negro

PANELES DE PARCHEO

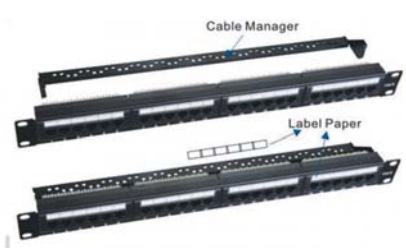

Paneles de parcheo 19" UTP dual + guía

- PA24U5E** Panel UTP Cat.5e 24 puertos 19" 1U dual + guía LSA 100 MHz
- PA24U6** Panel UTP Cat.6 24 puertos 19" 1U dual + guía LSA 250 MHz



Paneles de parcheo 19" FTP

- PA24F5E** Panel FTP Cat.5e 24 puertos 19" 1U LSA 100 MHz
- PA24F6** Panel FTP Cat.6 24 puertos 19" 1U LSA 250 MHz



Panel 1/2U

- PA24U605** Panel UTP Cat.6 24 puertos 19" 1/2U LSA 250 MHz



Panel UTP tipo Avaya

- PA24U62UX** Panel UTP Cat.6 24 puertos 19" 2U tipo Avaya



Panel UTP con bandeja

- PA37583/E** Panel UTP Cat.6 24 puertos 19" 1U con bandeja LSA 250 MHz



Referencia	Descripción
------------	-------------

- | | |
|----------------|--|
| PA37582 | Panel UTP Cat.5e 24 puertos 19" 1U con bandeja LSA 100 MHz |
| PA37583 | Panel UTP Cat.6 24 puertos 19" 1U con bandeja LSA 250 MHz |



Referencia	Descripción
------------	-------------

- | | |
|----------------|--|
| PA37584 | Panel UTP Cat.5e 24 puertos 19" 1U LSA 100 MHz |
| PA37585 | Panel UTP Cat.6 24 puertos 19" 1U LSA 250 MHz |



Referencia	Descripción
------------	-------------

- | | |
|----------------|--|
| PA37668 | Panel FTP Cat.5e 24 puertos 19" 1U 100 MHz |
| PA37667 | Panel FTP Cat.6 24 puertos 19" 1U 250 MHz |
| PA37666 | Panel FTP Cat.6A 24 puertos 19" 1U 500 MHz |



Referencia	Descripción
------------	-------------

- | | |
|----------------|--|
| PA37687 | Panel FTP Cat.6 48 huecos 19" 1U LSA 250 MHz |
|----------------|--|



Referencia	Descripción
------------	-------------

- | | |
|-------------------|--------------------------------------|
| PA11124115 | Panel modular 24 huecos 19" 1U negro |
|-------------------|--------------------------------------|



Referencia	Descripción
------------	-------------

- | | |
|----------------|--------------------------------|
| PA37580 | Panel modular 24 huecos 19" 1U |
|----------------|--------------------------------|

MÓDULOS Y CONECTORES



Módulos hembra RJ45 90° UTP tipo AMP

- CNH5EA** Módulo H RJ45 Cat.5e 90° 100 MHz negro
- CNH5EB** Módulo H RJ45 Cat.5e 90° 100 MHz blanco
- CNH5EX2** Módulo H RJ45 UTP Cat.5e 90° AMP 100 MHz



Módulos hembra RJ45 180° UTP tipo AMP

- CNH61** Módulo H RJ45 UTP Cat.6 180° 110 250 MHz negro
- CNH61B** Módulo H RJ45 UTP Cat.6 180° 110 250 MHz blanco
- CNH6X2N** Módulo H RJ45 UTP Cat.6 180° AMP 250 MHz



Módulos hembra RJ45 UTP tipo 3M montaje sin impactadora

- CNH5ER1** Módulo H RJ45 UTP Cat.5e 180° 100 MHz
- CNH6R1** Módulo H RJ45 UTP Cat.6 180° 250 MHz
- CNH6R1A** Módulo H RJ45 UTP Cat.6A 180° 500 MHz



Módulos hembra RJ45 FTP tipo 3M montaje sin impactadora

- CNH5ERS** Módulo H RJ45 FTP Cat.5e 180° 100 MHz
- CNHFK6** Módulo H RJ45 FTP Cat.6 180° 250 MHz
- CNHFK6A** Módulo H RJ45 FTP Cat.6A 180° 500 MHz



Módulos hembra RJ45 90°

- CNH5E9** Módulo H RJ45 Cat.5e 90° 100 MHz negro
- CNH69** Módulo H RJ45 UTP Cat.6 90° 250 MHz blanco
- CNH69N** Módulo H RJ45 UTP Cat.6 90° 250 MHz negro
- CNHK6** Módulo H RJ45 UTP Cat.6 180° 250 MHz blanco

Módulos hembra RJ45 180°

- CNH5E** Módulo H RJ45 UTP Cat.5e 180° 100 MHz blanco
- CNH5EN** Módulo H RJ45 UTP Cat.5e 180° 100 MHz negro
- CNH6** Módulo H RJ45 Cat.6 180° 250 MHz blanco
- CNH6N** Módulo H RJ45 Cat.6 180° 250 MHz negro



ECOLAN®



ECOLAN®



Módulos hembra RJ45 FTP montaje sin impactadora

- CN20072** Módulo H RJ45 FTP Cat.6 250 MHz
- CN20070** Módulo H RJ45 FTP Cat.6A 500 MHz

Módulos hembra RJ45 UTP montaje sin impactadora

- CN20080** Módulo H RJ45 UTP Cat.6 250 MHz blanco
- CN20081** Módulo H RJ45 UTP Cat.6 250 MHz negro

ECOLAN®



ECOLAN®



Módulos hembra RJ45 FTP

- CN20051** Módulo H RJ45 FTP Cat.5e 100 MHz
- CNH6** Módulo H RJ45 FTP Cat.6 250 MHz

Módulos hembra RJ45 UTP 180°

- CN20050** Módulo H RJ45 UTP Cat.5e 180° 100 MHz
- CN20061** Módulo H RJ45 UTP Cat.6 180° 250 MHz

IDEAL
technologies



IDEAL
technologies



Nuevos módulos hembra RJ45 180°

- ICNH6R1** Módulo H RJ45 Cat.6 180° 250 MHz blanco
- ICNH6R1N** Módulo H RJ45 Cat.6 180° 250 MHz negro
- ICNH6R1A** Módulo H RJ45 Cat.6A 180° 500 MHz blanco
- ICNH6R1AN** Módulo H RJ45 Cat.6A 180° 500 MHz negro

Nuevo módulo hembra RJ11 Cat.3

- CNH3A** Módulo H RJ11 Cat.3 180° blanco

LATIGUILLOS



Latiguillo Cat. 5e UTP PVC 100 MHz

Referencia K809x.x (color/longitud)
 Longitudes 0,5 - 1 - 1,5 - 2 - 3 - 5 - 7,5 - 10 - 15 - 20 - 25 - 30 m.
 Colores 1 2 3 4 5 7 8 9

Referencia K8456.x (longitud)
 Longitudes 0,5 - 1 - 1,5 - 2 - 3 - 5 - 7,5 - 10 - 15 - 20 - 25 - 30 - 50 m.
 Color ●



Latiguillo Cat. 5e FTP PVC 100 MHz

Referencia K546x.x (color/longitud)
 Longitudes 0,5 - 1 - 1,5 - 2 - 3 - 5 - 7,5 - 10 - 15 - 20 - 25 - 30 m.
 Colores 1 2 3 4 5

Referencia K5453.x (longitud)
 Longitudes 0,15 - 0,25 - 0,5 - 1 - 1,5 - 2 - 3 - 5 - 7,5 - 10 - 15 - 20 - 25 - 30 m.
 Color ●



nuevo



Latiguillo Cat. 5e UTP LSZH 100 MHz

Referencia IDL0118.x (longitud)
 Longitudes 0,5 - 1 - 1,5 - 2 - 3 - 5 - 7,5 - 10 - 15 - 20 m.
 Color ●



Latiguillo Cat. 5e SFTP PVC 100 MHz

Referencia K54x.x (color/longitud)
 Longitudes 0,25 - 0,5 - 1 - 1,5 - 2 - 3 - 5 - 7,5 - 10 - 15 - 20 - 25 - 30 m.
 Color 55 56 57 58 59 60



Latiguillo Cat. 5e UTP PVC Cruzados

Referencia K8097.x (longitud)
 Longitudes 0,5 - 1 - 1,5 - 2 - 3 - 5 - 7,5 - 10 - 15 - 20 - 25 - 30 m.
 Color ○



Latiguillo Cat. 5e SFTP PVC Cruzados

Referencia K5450.x (longitud)
 Longitudes 0,5 - 1 - 1,5 - 2 - 3 - 5 - 7,5 - 10 - 15 - 20 m.
 Color ●



Latiguillo Cat. 6 UTP LSZH Cruzados

Referencia LC0218.x (longitud)
 Longitudes 0,5 - 1 - 1,5 - 2 - 3 - 5 - 7,5 - 10 - 15 - 20 m.
 Color ○

*Bajo pedido se pueden fabricar en cualquier otra medida y configuración

LATIGUILLOS



Latiguillo Cat. 6 UTP PVC 250 MHz

Referencia K8100x.x (color/longitud)
Longitudes 0,5 - 1 - 1,5 - 2 - 3 - 5 - 7,5
 10 - 15 - 20 - 25 - 30 m.
Colores



Latiguillo Cat. 6 UTP LSZH 250 MHz

Referencia IDL021xx (color/longitud)
Longitudes 0.15 - 0.25 - 0.5 - 1 - 1.5 - 2 - 3 - 5 - 7,5
 10 - 15 - 20 - 25 - 30 - 50 m.
Colores



Latiguillo Cat. 6 UTP LSZH 250 MHz

Referencia K8104x.x (color/longitud)
Longitudes 0,25 - 0,5 - 1 - 1,5 - 2 - 3 - 5 - 7,5
 10 - 15 m.
Colores



Latiguillo plano Cat. 6 UTP LSZH 250 MHz

Referencia ELP020xx (color/longitud)
Longitudes 0,25 - 0,5 - 1 - 1,5 - 2 - 3 - 5 - 7,5 - 10 m.
Color



Latiguillo cruzado Cat. 5e FTP PVC 100 MHz

Referencia IDL1108x (longitud)
Longitudes 0,25 - 0,5 - 1 - 1,5 - 2 - 3 - 5 - 7,5
 10 - 15 - 20 - 25 - 30 - 50 m.
Color



Latiguillo cruzado Cat. 6 SFTP LSZH 250MHz

Referencia K5509.x (longitud)
Longitudes 0,5 - 1 - 2 - 3 - 5 - 10 - 15 - 20 m.
Color



Latiguillo Cat. 6 SFTP LSZH 250 MHz

Referencia K551x.x (color/longitud)
Longitudes 0,15 - 0,25 - 0,5 - 1 - 1,5 - 2 - 3 - 5 - 7,5
 10 - 15 - 20 - 25 - 30 m.
Colores



Latiguillo Cat. 6A SFTP LSZH 500 MHz

Referencia K5534x.x (color/longitud)
Longitudes 0,5 - 1 - 1,5 - 2 - 3 - 5 - 7,5
 10 - 15 - 20 - 25 m.
Colores
Referencia IDL2318x (longitud)
Longitudes 0.5 - 1 - 1.5 - 2 - 3 - 5 - 7.5
 10 - 15 - 20 - 25 - 30 - 50 m.
Color



Latiguillo Cat. 6 SFTP LSZH 250 MHz

Referencia IDL2218x (longitud)
Longitudes 1.5 - 2 - 3 - 5 - 7.5 - 10 - 15 - 20 m.
Colores

*Bajo pedido se pueden fabricar en cualquier otra medida y configuración

CABLE DE PARES



Cable UTP flexible Cat.5e

Referencia	IDL011xx (color/longitud)
Opción 1	0 2 4 5 6 8 100 m.
Opción 2	7 9 305 m.
Opción 3	6 500 m.



Cable UTP flexible Cat.6

Referencia	IDL021xx (color/longitud)
Opción 1	0 2 4 5 6 8 100 m.
Opción 2	7 9 305 m.



Cable UTP rígido

CAU5EL	Cable Cat.5e UTP LSZH rígido 305 m.
CAU6L	Cable Cat.6 UTP LSZH rígido 305 m.
CAU6AL	Cable Cat.6A UTP LSZH rígido 305 m.



Cable FTP rígido

CAF5EL	Cable Cat.5e FTP LSZH rígido 305 m.
---------------	-------------------------------------



Cable FTP rígido

CAF6L	Cable Cat.6 FTP LSZH rígido 305 m.
--------------	------------------------------------



Cable UTP Cat.3

CAU1PAZS	Cable UTP sólido 1 par 305 m. azul
CAU2PAZS	Cable UTP sólido 2 pares 305 m. azul



Cable UTP para exterior 305 m.

CAU5EX	Cable Cat.5e UTP exterior 305 m.
CAU6EX	Cable Cat.6 UTP exterior 305 m.



Cable FTP para exterior 305 m.

CAF5EX	Cable Cat.5e FTP exterior 305 m.
CAF6EX	Cable Cat.6 FTP exterior 305 m.



Cable FTP LSZH Cat.6 flexible 100 m.

Referencia	IDL211x100 (color/longitud)
Opción 1	2 4 5 6 8 100 m.



Cable SFTP Cat.6 flexible

Referencia	CASF6x (color)
Colores	A AZ G R V



Cable SFTP rígido

CASF5E	Cable Cat.5e SFTP FRNC rígido 305 m.
CASF6	Cable Cat.6 SFTP FRNC rígido 305 m.
CASF7	Cable Cat.7 SFTP FRNC rígido 305 m.

ADAPTADORES / ROSETAS



Adaptadores Keystone F.O.

ADE2000	Adaptador Keystone E2000
ADSC/LC	Adaptador Keystone SC/LC
ADST	Adaptador Keystone ST



Adaptadores Keystone RCA

AD493	Adaptador Keystone RCA rojo
AD494	Adaptador Keystone RCA blanco
AD495	Adaptador Keystone RCA amarillo



Adaptadores Keystone USB

AD498	Adaptador Keystone 2.0 USB A/A H/H
AD534	Adaptador Keystone 2.0 USB A/B H/H



Adaptadores Keystone BNC

AD497	Adaptador Keystone minijack estéreo 3,5mm.
ADBNC	Adaptador Keystone BNC



Adaptadores Keystone HDMI

AD479	Adaptador Keystone HDMI tipo A H/H
AD479V2	Adaptador Keystone HDMI tipo A H/H ECOLAN



Rosetas vacías

RTS	Roseta sencilla vacía hueco Keystone
RTD	Roseta doble vacía hueco Keystone



Tapas frontales para rosetas vacías

RTC5SP	Tapa roseta sencilla RJ45 con persiana 80x80 mm.
RTC5SP86	Tapa roseta sencilla RJ45 con persiana 86x86 mm.
RTC5DP	Tapa roseta doble RJ45 con persiana 80x80 mm.
RTC5DP86	Tapa roseta doble RJ45 con persiana 86x86 mm.
RTC5TP86	Tapa roseta triple RJ45 86x86 mm.
RTC5CP86	Tapa roseta cuádruple RJ45 con persiana 86x86 mm.

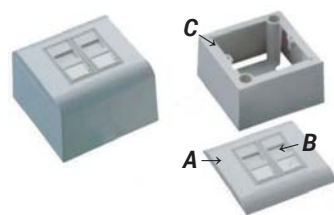

Rosetas de superficie

RT80	Marco roseta 80x80 mm. (A)
RT150	Marco roseta 80x150 mm. (A)
RTM	Módulo con ventana 45x22,5 mm. (B)
RTC80	Caja de superficie 80x80 mm. (C)
RTC815	Caja de superficie 80x150 mm. (C)
RTCP	Tapa ciega 45x22,5 mm.
RTCP1	Tapa ciega 45x45 mm.

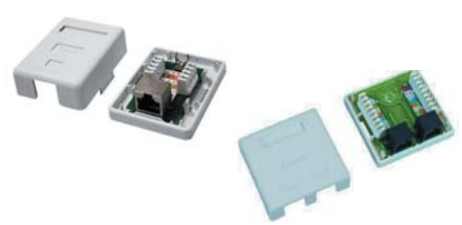

Tapas frontales para rosetas vacías

RTC5	Roseta sencilla Cat.5e UTP RJ45
RTC5D	Roseta doble Cat.5e UTP RJ45
RTC6	Roseta sencilla Cat.6 UTP RJ45
RTC6D	Roseta doble Cat.6 UTP RJ45
RTS6F	Roseta sencilla Cat.6 FTP RJ45
RTD6F	Roseta doble Cat.6 FTP RJ45



Cajas de superficie

RTC80A	Caja superficie 80x80mm. fondo 4,5mm.
RTC86	Caja superficie 86x86mm. fondo 2,5mm.
RTC86A	Caja superficie 86x86mm. fondo 3,8mm.



Bases de enchufe

145909B	Base enchufe 45x45mm. blanca
145909R	Base enchufe 45x45mm. roja
1459091	Base enchufe 45x45mm. económica

ACCESORIOS

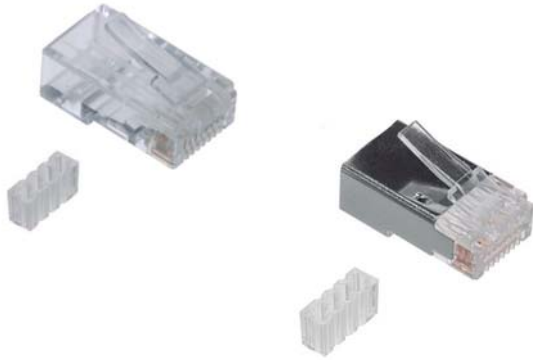

Conectores macho RJ45/RJ49

CNRJ45	Conector RJ45 Cat.5e flexible
CNRJ45R	Conector RJ45 Cat.5e rígido/flexible
CNRJ45C6	Conector RJ45 Cat.6 rígido/flexible
CNRJ45C6X	Conector RJ45 Cat.6 rígido/flexible con guía
CNRJ49	Conector RJ49 Cat.5e apantallado rígido/flexible
CNRJ49C6	Conector RJ49 Cat.6 apantallado rígido/flexible
CNRJ49C6A	Conector RJ49 Cat.6A apantallado rígido/flexible
CNRJ49C6X	Conector RJ49 Cat.6A apantallado rígido/flexible con guía
CNRJ49C7	Conector RJ49 Cat.7 apantallado rígido/flexible

Conectores, protectores y guías Hirose

PTR37540.4	Protector RJ49 Hirose
PTR37641.4	Protector RJ49 desmontable tipo libro Hirose
PTR375491	Protector RJ49 codo salida lateral (A)
PTR375492	Protector RJ49 codo (B)
CNTM11	Conector RJ49 macho Cat.5e TM11 Hirose
CNTM21	Conector RJ49 macho Cat.6 TM21 Hirose
CNTM31	Conector RJ49 macho Cat.6A TM31 Hirose
GCNTM11	Guía para conectores Hirose TM11
GCNTM21	Guía para conectores Hirose TM21
GCNTM31	Guía para conectores Hirose TM31



Tapones y tapas Keystone

TKC	Tapa ciega para hueco Keystone
TRJ45	Tapón Keystone RJ45 negro

Adaptadores Keystone RJ45

ADHHC5	Adaptador Keystone RJ45 Cat.5e UTP H/H
ADHHC5EF	Adaptador Keystone RJ45 Cat.5e FTP H/H
ADHHC6	Adaptador Keystone RJ45 Cat.6 UTP H/H
ADHHC6FA	Adaptador Keystone RJ45 Cat.6 FTP H/H

Adaptadores Keystone RJ45 panel

AD37486	Adaptador Keystone RJ45 Cat.6 FTP H/H panel
AD37488	Adaptador Keystone RJ45 Cat.6 UTP H/H panel
AD37521	Adaptador Keystone RJ45 Cat.6A FTP H/H panel



Protectores con nido

Referencia	PTRJ45x (color)
Colores	A AZ B G N R V

Protectores mini

Referencia	PTRJ45Mx (color)
Colores	A AZ B G N R V

Protectores con bloqueo de seguridad

Referencia	PTRJ45xMP (color)
Colores	A AZ B G R V



Dobladores de punto

AD1M2H1	Doblador de punto Cat.5e D/D 1M/2H
AD1M2H2	Doblador de punto Cat.5e V/D 1M/2H
AD1M2H3	Doblador de punto Cat.5e V/V 1M/2H
AD5126	Doblador de punto Cat.6 D/D 1M/2H



Adaptadores sub D configurables

AD9H45	Adaptador sub D configurable 9 H / RJ45
AD9M45	Adaptador sub D configurable 9 M / RJ45
AD25H45	Adaptador sub D configurable 25 H / RJ45
AD25M45	Adaptador sub D configurable 25 M / RJ45



Adaptadores Keystone para carril DIN

AD25184	Adaptador Keystone carril DIN abierto
AD25186	Adaptador Keystone carril DIN cerrado



Adaptador cruzado

AD37537	Adaptador M/H RJ45 cruzado
----------------	----------------------------



Cajas de empalme

C37596	Caja de empalme Cat.6 inserción LSA
---------------	-------------------------------------



Bridas con bandera (100 uds.)

BRE10025	Brida con bandera 100x2,5 mm.
BRE11025	Brida con bandera 110x2,5 mm.
BRE20036	Brida con bandera 200x3,6 mm.
BRE20045	Brida con bandera 200x4,5 mm.



Rollos cinta velcro 25 m.

Referencia	VELx25 (anchura)
Anchuras	10 - 13 - 16 - 20 - 25 mm.



Bridas velcro (750 uds.)

BR20020A	Brida velcro 200x20 mm. azul
BR20020B	Brida velcro 200x20 mm. blanca
BR20020N	Brida velcro 200x20 mm. negra



Bridas de nylon

Referencia	
Longitudes	100, 160, 200, 250, 280, 360, 430 mm.
Anchos	2,5 - 2,6 - 3,6 - 4,8 mm.
Colores	● ○



Cuerda de fijación

BR6JS	Zócalo adhesivo para bridas 9 mm.
BR12JS	Zócalo adhesivo para bridas 18 mm.
C6840B	Cuerda encerada de poliamida 1,4x0,62 mm.



Etiquetas para cables

LJSL9Y32.5	Etiquetas para cables Panduit
-------------------	-------------------------------

ISDN / SISTEMA 110



Latiguillos 1 par ISDN

Referencia CAU51Pxx (longitud/color)
Longitudes 0,5 - 1 - 1,5 - 2 - 3 - 5 m.
Color AZ G



Latiguillos 2 pares ISDN

Referencia CAU2Px (longitud)
Longitudes 0,5 - 1 - 1,5 - 2 - 3 - 6 - 10 m.
Color ●



Paneles de parcheo 19" para voz

PA25C3 Panel ISDN Cat.3 25 puertos
19" 1U Krone LSA
PA50C3 Panel ISDN Cat.3 50 puertos
19" 1U Krone LSA



Paneles de parcheo Sistema 110

PA11001 Panel 19" 1U Sistema 110 100 pares



Bloques 110

BL1104P Bloque de conexión 110 4 pares
BL1105P Bloque de conexión 110 5 pares



Regleta 110

PA1111 Regleta 50 pares Sistema 110 sin patas



Patas y pasacables 110

PA110 Kit de patas Sistema 110
PAS06 Panel pasacables Sistema 110 19" 1U
PAS065 Panel pasacables Sistema 110 50 pares



Latiguillos 110/RJ45

Referencia CAU5xPx (nºpares / longitud)
Longitudes 1 - 2 - 3 - 5 - 7,5 - 10 m.
Nº de pares 1 - 2 - 4



Latiguillos 110/110

Referencia CA110xx (nºpares / longitud)
Longitudes 1 - 2 - 3 - 5 - 7,5 - 10 m.
Nº de pares 1 - 2 - 4



Multiplexores ICT 2

AD37531 Adaptador RJ45 ISDN M/H 15 cm. 4 salidas
AD5117 Adaptador RJ45 ISDN M/H 15 cm. 5 salidas
AD5269 Adaptador RJ45 ISDN M/H 15 cm. 8 salidas

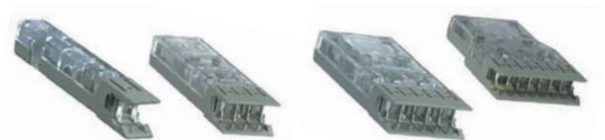

Conectores 110

CN1101A Conector 110 1 par AMP
CN1101B Conector 110 1 par
CN1102A Conector 110 2 pares AMP
CN1102P Conector 110 2 pares
CN1104A Conector 110 4 pares AMP
CN1104P Conector 110 4 pares

Herramientas, téster y certificadores

TÉSTER, CERTIFICADORES Y CRIMPADORAS



Referencia	Descripción
TES01	Lan Tester RJ11, RJ45 y USB con remoto

Referencia	Descripción
TES03	Lan Tester RJ11, RJ12 y RJ45 con remoto económico

Referencia	Descripción
SONDA	Sonda localizadora de fallos



Referencia	Descripción
HR4106	Herramienta crimpar RJ con Lan Tester incorporado

Referencia	Descripción
33-991	Certificador LANTEK II - 350
33-992	Certificador LANTEK II - 500



Referencia	Descripción
HR330K	Maletín de crimpar coaxiales
HR3C5D	Maletín de crimpar terminales eléctricos

Referencia	Descripción
HR02	Herramienta coaxial Flex 2, 3, 5
HR336J	Herramienta coaxial Flex 3, ST212, RG174
HR336K	Herramienta coaxial RG213, RG214
HR336G	Herramienta coaxial RG174, RG58, RG59

Referencia	Descripción
HR05	Herramienta conectores Sub-D, V35
HR007	Herramienta terminales (+ 3 mordazas)
HSC8	Herramienta para contactos tipo DMC AMF8
HRSC8	Herramienta de punteras



Referencia *Descripción*
HR322 *Pela cables coaxial 3 cuchillas*



Referencia *Descripción*
HR323 *Pela cables cilíndrico
RG6, RG8, RG11 Y RG59*



Referencia *Descripción*
HRP02 *Pela cables coaxial cilíndrico*



Referencia *Descripción*
HRS501B *Pela cables UTP universal*



Referencia *Descripción*
HR501E *Pela cables clip RG6, RG8, RG59 y RG214*



Referencia *Descripción*
HRD3 *Pela cables autoajustable universal*



Referencia *Descripción*
HR731 *Pela cables multifunción*

ALICATES Y EXTRACTORES



Referencia	Descripción
HR330A	Alicate corta cable grande

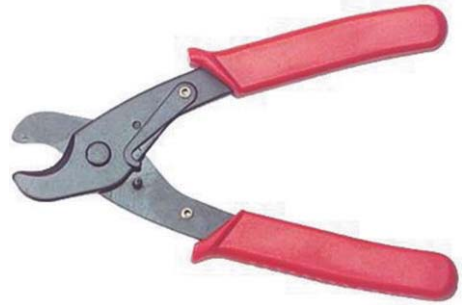

Referencia	Descripción
HRA02	Alicate corta cable pequeño



Referencia	Descripción
HRCFS2	Alicate fibra óptica Class



Referencia	Descripción
HR39806	Alicate corta cables electrónica



Referencia	Descripción
HR228F	Herramienta extractor conectores "F" largo 20 cm.



Referencia	Descripción
HR104	Tijera multifunción



Referencia	Descripción
HR315DR	Herramienta de impacto Sistema 110 5 pares



Referencia	Descripción
HRM01	Base para impactar módulos RJ45



Referencia	Descripción
HRI02	Herramienta de impacto Sistema 110
HR102R	Cuchilla de repuesto para herramienta de impacto Sistema 110



Referencia	Descripción
HRI05	Herramienta de impacto QDF de cuello corto



Referencia	Descripción
HRI04	Herramienta de impacto QDF de cuello largo



Referencia	Descripción
HR106	Impactadora reversible tipo Krone Pouyet



Referencia	Descripción
HRU506	Chipi chopo 0,5/0,6 punta única azul



Referencia	Descripción
HRV506	Chipi chopo 0,5/0,6 reversible negro



Referencia	Descripción
HRDU	Chipi chopo desenrollador universal

HERRAMIENTAS NETWORK



Referencia	Descripción
HR2008	Herramienta crimpar RJ9, 11, 12 Y 45 sin carraca



Referencia	Descripción
HR3	Herramienta crimpar RJ9, 11, 12 Y 45 con carraca



Referencia	Descripción
HR318	Herramienta crimpar RJ11, 12 Y 45 con carraca



Referencia	Descripción
HR500R	Herramienta crimpar RJ11, 12 Y 45 con carraca



Referencia	Descripción
HR568R	Herramienta crimpar RJ11, 12 Y 45 sin carraca



Referencia	Descripción
HR8086R	Herramienta crimpar RJ11, 12 Y 45 con carraca

I.C.T. y telefonía



Cables telefónicos rizados

- L002** Cable telefónico rizado RJ11 2m. negro
- L005** Cable telefónico rizado RJ11 5m. negro
- L012** Cable telefónico rizado RJ11 2m. marfil
- L015** Cable telefónico rizado RJ11 5m. marfil



Latiguillos telefónicos planos

- L101** Cable telefónico plano RJ11 1m. negro
- L102** Cable telefónico plano RJ11 2m. negro
- L103** Cable telefónico plano RJ11 3m. negro
- L105** Cable telefónico plano RJ11 5m. negro
- L112** Cable telefónico plano RJ11 2m. marfil
- L115** Cable telefónico plano RJ11 5m. marfil



Cable telefónico

- CATP4M** Cable telefónico plano 4 vías marfil 100m.
- CATP4N** Cable telefónico plano 4 vías negro 100m.
- CATP6M** Cable telefónico plano 6 vías marfil 100m.
- CATP6N** Cable telefónico plano 6 vías negro 100m.
- CATP8M** Cable telefónico plano 8 vías marfil 100m.
- CATP8N** Cable telefónico plano 8 vías negro 100m.



Rosetas salida lateral

- RT01A** Roseta telefónica 6/4 salida lateral marfil
- RT01C** Roseta telefónica 8/8 salida lateral marfil



Roseta salida lateral mini

- RT05** Roseta telefónica mini 6/4



Rosetas salida frontal

- RT06A** Roseta telefónica 6/4 salida frontal marfil
- RT06B** Roseta telefónica 6/6 salida frontal marfil



Cables de acometida telefónica

- CAACO1P** Cable acometida telefónica 1 par 250 m.
- CAACO2P** Cable acometida telefónica 2 pares 250 m.



Empalmador telefónico

- ADT04A** Adaptador empalmador telefónico 6/4
- ADT04B** Adaptador empalmador telefónico 6/6
- ADT04C** Adaptador empalmador telefónico 8/8



Conectores RJ

- CNRJ9** Conector telefónico RJ9 4P4C
- CNRJ10** Conector telefónico RJ10 patilla desplazada
- CNRJ11** Conector telefónico RJ11 6P4C
- CNRJ12** Conector telefónico RJ12 6P6C
- CNRJ48** Conector telefónico RJ48 10 vías

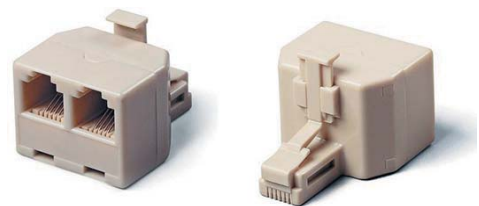

Duplicador telefónico

- ADT01A** Adaptador telefónico RJ11 6/4 1M/2H marfil
- ADT01AB** Adaptador telefónico RJ11 6/4 1M/2H blanco
- ADT01B** Adaptador telefónico RJ12 6/6 1M/2H marfil
- ADT01C** Adaptador telefónico RJ45 8/8 1M/2H marfil
- ADT02** Adaptador telefónico RJ11 6/4 1M/3H marfil
- ADT02B** Adaptador telefónico RJ11 6/4 1M/3H blanco
- ADT03A** Adaptador telefónico RJ11 6/4 1H/2H marfil
- ADT03C** Adaptador telefónico RJ45 8/8 1H/2H marfil

CAJAS DE REGISTRO / REGLETAS DE CORTE Y PRUEBA

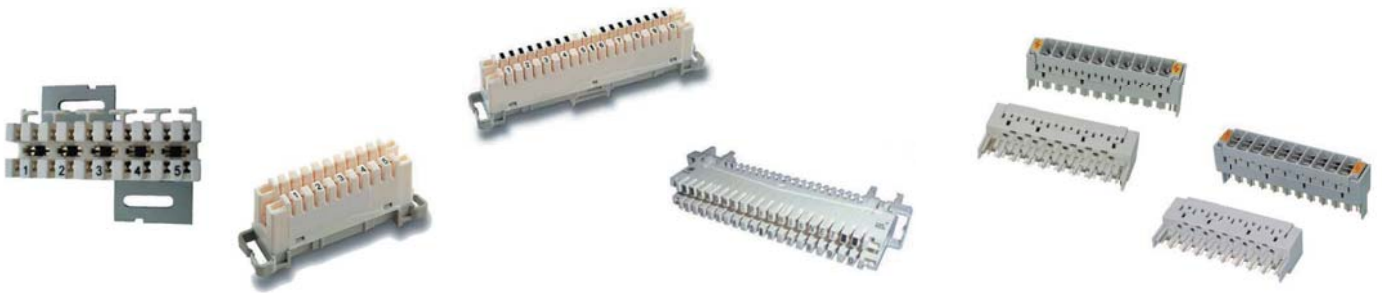

Regletas 5 pares

- RGCP5PCS** Regleta de corte y prueba
5 pares LSA atornillar
- RGCP5PSS** Regleta de corte y prueba
5 pares LSA

Regletas 10 pares

- RGCP10P** Regleta de corte y prueba
10 pares LSA
- RGCP10PP** Regleta de corte y prueba
10 pares LSA perfil

Módulos protección para regleta

- MPBP10P** Módulo protección bipolar
para regleta
- MPTR10P** Módulo protección tripolar
para regleta



Cajas de distribución interior

- CAJICT30P** Caja distribución interior 30 pares con llave
- CAJICT50P** Caja distribución interior 50 pares con llave
- CAJICT100P** Caja distribución interior 100 pares con llave



Cajas de distribución exterior

- CAJEX30P** Caja distribución exterior 30 pares con llave
- CAJEX50P** Caja distribución exterior 50 pares con llave
- CAJEX100P** Caja distribución exterior 100 pares con llave



Cajas de distribución exterior IP

- CAJEX30P1** Caja de distribución exterior 30 pares tipo A-30



Armarios I.C.T.

- R403015** Armario metálico I.C.T. 400x300x150
- R7050** Armario metálico I.C.T. 70x50x15 vertical
- R4545CT** Armario metálico I.C.T. 45x45x15 con tapas
- R10055CT** Armario metálico I.C.T. 100x55x15 con tapas

ACCESORIOS



Conectores de presión

- CNUY2** Conector presión 2 hilos UY2 (100 uds.)
- CNUR2** Conector presión 3 hilos UR2 (100 uds.)
- CNUG** Conector presión 2 hilos UG2



Clavijas de corte

- CN1026R** Clavija de corte 1 par rojo LSA

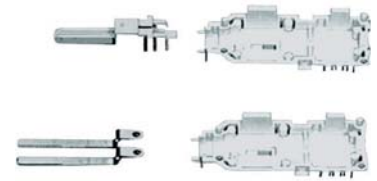

Clavijas tipo Krone

- CNBK02** Clavija bipolar tipo Krone
- CNTK04** Clavija tetrapolar tipo Krone



Conectores de presión

- MPR5P** Marco porta rótulos abatible regleta 5 pares gris
- MPR10P** Marco porta rótulos abatible regleta 10 pares gris



Conectores de presión

- DGB2P** Descargador de gas bipolar 75/90/150/230/350 V
- DGT3PFS** Descargador tripolar for safe 75/90/150/230/350 V



Soportes porta regletas

- SOP1R5P** Soporte porta regleta para 1 regleta 5 pares
- SOP1R10P** Soporte porta regleta para 1 regleta 10 pares
- SOP3R10P** Soporte porta regleta para 3 regletas 10 pares
- SOP5R10P** Soporte porta regleta para 5 regletas 10 pares
- SOP10R10P** Soporte porta regleta para 10 regletas 10 pares



Subracks tipo Krone

- SRK601** Subrack 19" 1U 60 pares tipo Krone
- SRK902** Subrack 19" 2U 90 pares tipo Krone
- SRK1503** Subrack 19" 3U 150 pares tipo Krone
- SRK1804** Subrack 19" 4U 180 pares tipo Krone



Herramienta de apriete

- HRUY** Herramienta de apriete conectores UY



Herramienta de impacto

- HRI03S** Impactadora LSA tipo Krone con sensor



Antienredo telefónico

- AD2** Antienredo auricular estrecho

Racks y accesorios

MURAL SERIE RME



- Cumple con ANSI/EIA, RS-310-D, DIN41491; PART1, IEC297-2, DIN41494; PART7, GB/T3047.2-92
- Compatible con ETSI y los estándares de 19".
- Diseño robusto y moderno de dimensiones precisas.
- Fácil montaje en pared. También se puede colocar en el suelo mediante patas o ruedas.
- Capacidad de carga: 60 kg.
- Entrada de cableado superior e inferior con posibilidad de cierre.
- Puerta delantera y panel lateral desmontables.
- Fácil montaje y mantenimiento.
- Acabados: desengrasado, pretratamiento desmineralizante y fosfatado de hierro.
- Colores disponibles: gris y negro.
- Gama completa de accesorios



DESPIECE ESTRUCTURAL

1. Marco
2. Puerta lateral
3. Placa de montaje
4. Perfiles de montaje
5. Puerta frontal
6. Cerradura

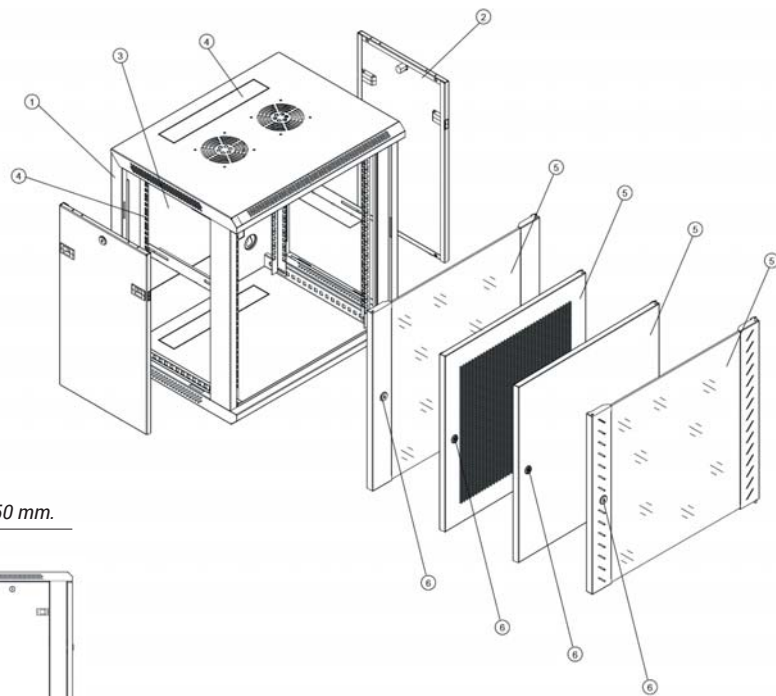

600 mm.

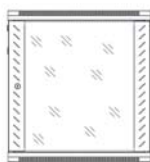

Vista frontal

450 mm.

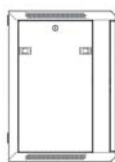

Vista lateral

OPCIONES

Especificación	Cantidad	Unidades	Material	Acabado	Opciones
Marco	1	Piezas	0,8 mm. acero laminado en frío	Polvo	-
Puerta frontal	1	Piezas	0,8 mm. acero laminado en frío	-	Tipo de puerta B
Puerta lateral	2	Piezas	0,8 mm. acero laminado en frío	Polvo	Con cerradura
Cerradura	1	Piezas	-	-	-
Perfilería	4	Piezas	1,2 mm. acero laminado en frío	Polvo	-
Placa de montaje	1	Piezas	0,8 mm. acero laminado en frío	Polvo	-
Tapa de entrada de cable	2	Piezas	0,8 mm. acero laminado en frío	Polvo	-
Tornillería	10	Sets	-	-	-
Llave	1	Piezas	-	-	-

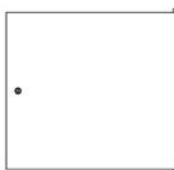
TIPOS DE PUERTAS

Puerta abatible de acero (A)

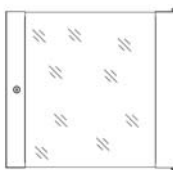

Puerta de cristal templado gris (B)

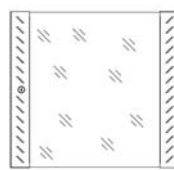

Puerta de cristal templado gris con el marco perforado (C)

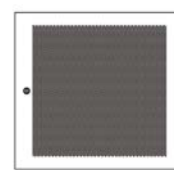

Puerta de acero perforada de gran ventilación (tipo hexagonal) (D)

Referencia	Descripción
RME1445	Rack mural 19" 4U 1 cuerpo F-450 mm. puerta de cristal RAL9004
RME1445S	Rack mural 19" 4U 1 cuerpo F-450 mm. puerta ciega RAL9004
RME1645	Rack mural 19" 6U 1 cuerpo F-450 mm. puerta de cristal
RME1945	Rack mural 19" 9U 1 cuerpo F-450 mm. puerta de cristal
RME11245	Rack mural 19" 12U 1 cuerpo F-450 mm. puerta de cristal
RME11545	Rack mural 19" 15U 1 cuerpo F-450 mm. puerta de cristal RAL9004

MURAL SERIE RM1



- Cumple con ANSI/EIA, RS-310-D, DIN41491; PART1, IEC297-2, DIN41494; PART7, GB/T3047.2-92
- Compatible con ETSI y los estándares de 19".
- Cuidado diseño, estructura sólida y fiable.
- Fácil de anclar a la pared.
- Capacidad de carga: 60 kg.
- Puerta delantera de cristal templado con cerradura.
- Paneles laterales desmontables.
- Accesorios incluidos: bandeja, sistema de ventilación, etc.

600 mm.

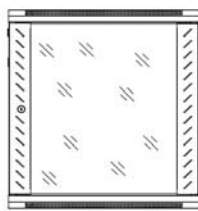

Vista frontal

450 mm.

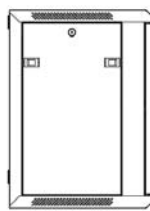

Vista lateral



Referencia	Descripción
RM1445	Rack mural 19" 4U 1 cuerpo F-450 mm. puerta de cristal RAL9004
RM1445S	Rack mural 19" 4U 1 cuerpo F-450 mm. puerta ciega
RM1645	Rack mural 19" 6U 1 cuerpo F-450 mm. puerta de cristal RAL9004
RM166	Rack mural 19" 6U 1 cuerpo F-600 mm. puerta de cristal RAL9004
RM1945	Rack mural 19" 9U 1 cuerpo F-450 mm. puerta de cristal RAL9004
RM196	Rack mural 19" 9U 1 cuerpo F-600 mm. puerta de cristal RAL9004
RM11245	Rack mural 19" 12U 1 cuerpo F-450 mm. puerta de cristal RAL9004
RM1126	Rack mural 19" 12U 1 cuerpo F-600 mm. puerta de cristal RAL9004
RM11545	Rack mural 19" 15U 1 cuerpo F-450 mm. puerta de cristal RAL9004
RM11545B	Rack mural 19" 15U 1 cuerpo F-450 mm. puerta de cristal RAL7004
RM1156	Rack mural 19" 15U 1 cuerpo F-600 mm. puerta de cristal RAL9004

DESPIECE ESTRUCTURAL

1. Estructura
2. Puertas laterales
3. Cuerpo
4. Perfiles
5. Puerta frontal
6. Cerradura

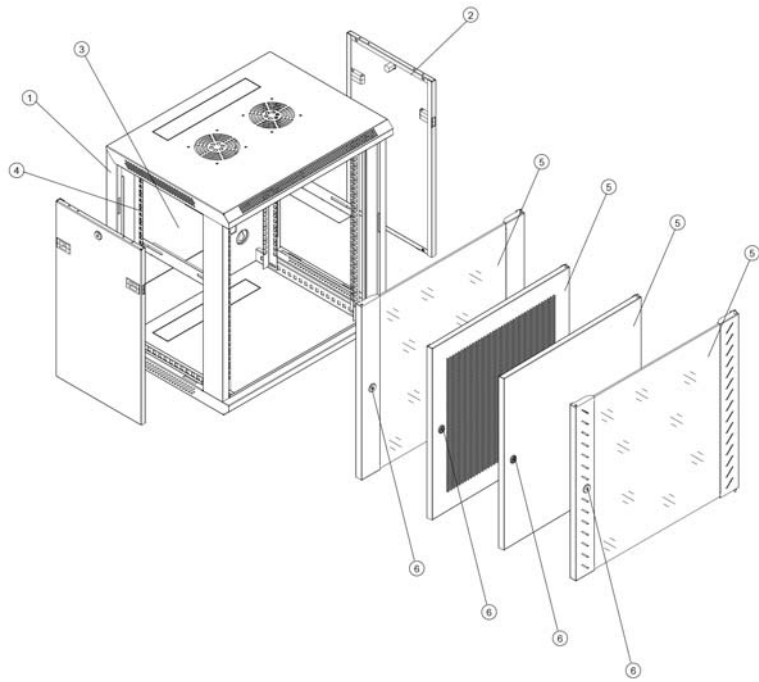
OPCIONES

Especificación	Cantidad	Unidades	Material	Acabado	Opciones
Marco bastidor	2	Piezas	1,2 mm. acero laminado en frío	Polvo	-
Puerta frontal	1	Piezas	1,2 mm. acero laminado en frío	-	Tipo de puerta B
Puerta lateral	2	Piezas	1,2 mm. acero laminado en frío	Polvo	Con cerradura
Cerradura	1	Piezas	-	-	-
Perfilería	4	Piezas	1,5 mm. acero laminado en frío	Polvo	-
Cuerpo	1	Piezas	1,2 mm. acero laminado en frío	Polvo	-
Suelo	2	Piezas	1,2 mm. acero laminado en frío	Polvo	-
Tornillería	10	Sets	-	-	-
Llave	1	Piezas	-	-	-

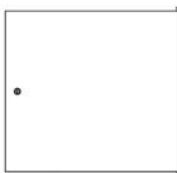
TIPOS DE PUERTAS

Puerta ciega (A)

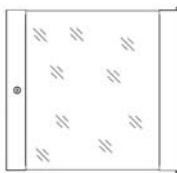

Puerta con cristal ahumado (B)

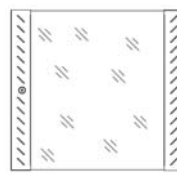

Puerta con cristal ahumado y laterales perforados (C)

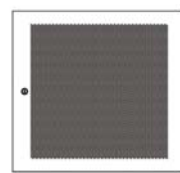

Puerta perforada (D)

MURAL SERIE RM2



- Cumple con ANSI/EIA, RS-310-D, DIN41491; PART1, IEC297-2, DIN41494; PART7, GB/T3047.2-92
- Compatible con ETSI y los estándares de 19".
- Diseño robusto y moderno de dimensiones precisas.
- Fácil montaje en pared. También se puede colocar en el suelo mediante patas o ruedas.
- Capacidad de carga: 60 kg.
- Entrada de cableado superior e inferior con posibilidad de cierre.
- Puerta delantera y panel lateral desmontables.
- Acabados: desengrasado, pretratamiento desmineralizante y fosfatado de hierro.
- Colores disponibles: gris y negro.
- Gama completa de accesorios.

Referencia	Descripción
RM2655	Rack mural 19" 6U 2 cuerpos F-550 mm. puerta de cristal RAL9004
RM2955	Rack mural 19" 9U 2 cuerpos F-550 mm. puerta de cristal RAL9004
RM21555	Rack mural 19" 15U 2 cuerpos F-550 mm. puerta de cristal RAL9004

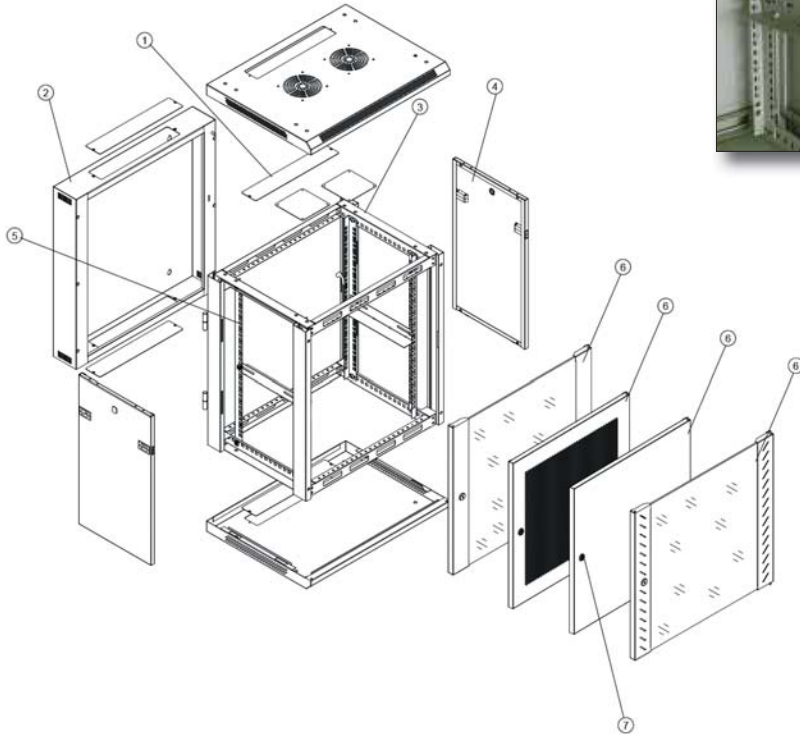

DESPIECE ESTRUCTURAL

1. Placa de montaje
2. Puerta trasera
3. Marco
4. Puerta lateral
5. Perfil de montaje
6. Puerta frontal
7. Cerradura

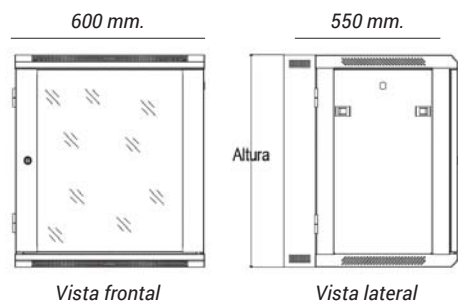

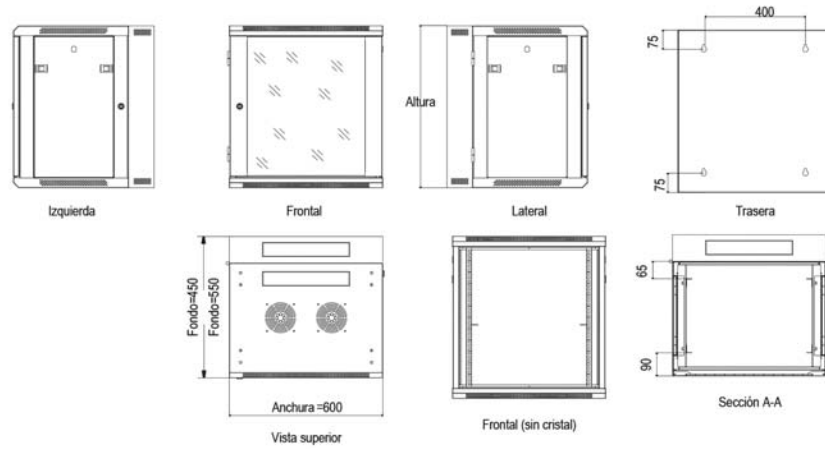

OPCIONES

Especificación	Cantidad	Unidades	Material	Acabado	Opciones
Marco	4	Piezas	1,2 mm. acero laminado en frío	Polvo	-
Puerta frontal	1	Piezas	1,2 mm. acero laminado en frío	Polvo	Tipo de puerta B
Puerta lateral	2	Piezas	1,2 mm. acero laminado en frío	Polvo	Con cerradura
Puerta trasera	1	Piezas	-	-	-
Cerradura	1	Piezas	-	-	-
Perfilería	4	Piezas	1,5 mm. acero laminado en frío	Polvo	-
Placa de montaje	1	Piezas	1,2 mm. acero laminado en frío	Polvo	-
Tapa de entrada de cable	2	Piezas	1,2 mm. acero laminado en frío	Polvo	-
Tornillería	10	Sets	-	-	-
Llave	1	Piezas	-	-	-

TIPOS DE PUERTAS

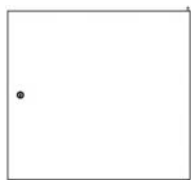

Puerta abatible de acero (A)

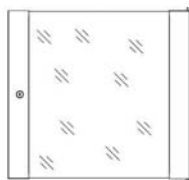

Puerta de cristal templado gris (B)

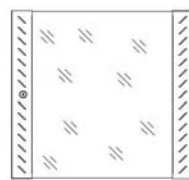

Puerta de cristal templado gris con el marco perforado (C)

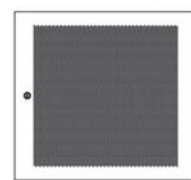

Puerta de acero perforada de gran ventilación (tipo hexagonal) (B)

RACK SERIE RC



- Cumple con ANSI/EIA, RS-310-D, DIN41491; PART1, IEC297-2, DIN41494; PART7, GB/T3047.2-92
- Compatible con ETSI y los estándares de 19".
- Diseño robusto y moderno de dimensiones precisas.
- Buena compatibilidad con otros fabricantes.
- Puerta delantera y trasera que permiten una perfecta ventilación y un funcionamiento fiable.
- Entrada de cableado superior e inferior con posibilidad de cierre y ajuste.
- Zócalo opcional.
- Panel lateral de fácil montaje.
- Techo con tapa y unidad de ventilación.
- Patas regulables en altura y ruedas con freno.
- Carga máxima: 800 kg.
- Gama completa de accesorios.

Referencia	Descripción
RC2269	Rack Serie RC 19" 22U 600x900 mm. delantera cristal y trasera ciega
RC2269P	Rack Serie RC 19" 22U 600x900 mm. delantera cristal y trasera perforada
RC2288P	Rack Serie RC 19" 22U 800x800 mm. delantera cristal y trasera perforada
RC3269	Rack Serie RC 19" 32U 600x900 mm. delantera cristal y trasera ciega
RC3769	Rack Serie RC 19" 37U 600x900 mm. delantera cristal y trasera ciega
RC3769P	Rack Serie RC 19" 37U 600x900 mm. delantera cristal y trasera perforada
RC4268	Rack Serie RC 19" 42U 600x800 mm. delantera cristal y trasera ciega
RC4268P	Rack Serie RC 19" 42U 600x800 mm. delantera cristal y trasera perforada
RC4268CDP	Rack Serie RC 19" 42U 600x800 mm. delantera cristal y trasera perforada doble
RC42610	Rack Serie RC 19" 42U 600x1000 mm. delantera cristal y trasera ciega
RC42610P	Rack Serie RC 19" 42U 600x1000 mm. delantera cristal y trasera perforada
RC4288	Rack Serie RC 19" 42U 800x800 mm. delantera cristal y trasera ciega
RC4288P	Rack Serie RC 19" 42U 800x800 mm. delantera cristal y trasera perforada
RC4288CDP	Rack Serie RC 19" 42U 800x800 mm. delantera cristal y trasera perforada doble
RC42810	Rack Serie RC 19" 42U 800x1000 mm. delantera cristal y trasera ciega
RC42810CDP	Rack Serie RC 19" 42U 800x1000 mm. delantera cristal y trasera perforada doble
RC42810DP	Rack Serie RC 19" 42U 800x1000 mm. delantera y trasera perforadas
RC4766P	Rack Serie RC 19" 47U 600x600 mm. delantera cristal y trasera perforada
RC4766PP	Rack Serie RC 19" 47U 600x600 mm. delantera y trasera perforadas
RC4788DP	Rack Serie RC 19" 47U 800x800 mm. delantera y trasera perforadas
RC47810DP	Rack Serie RC 19" 47U 800x1000 mm. delantera y trasera perforadas

OPCIONES

Especificación	Cantidad	Unidades	Material	Acabado	Opciones
Cubierta superior	1	Piezas	1,2 mm. acero laminado en frío	Polvo	-
Marco bastidor	2	Piezas	1,2 mm. acero laminado en frío	Polvo	-
Puerta delantera	1	Piezas	1,2 mm. acero laminado en frío	Polvo	Tipo de puerta
Panel lateral	4	Piezas	1,2 mm. acero laminado en frío	Polvo	Con cerradura
Puerta trasera izquierda	1	Piezas	1,2 mm. acero laminado en frío	Polvo	Tipo de puerta A
Cerradura	1	Piezas	-	-	-
Perfilería	6	Piezas	2,0 mm. acero laminado en frío	Polvo	1,5 mm. para 66
Ángulo de montaje	4	Piezas	1,2 mm. acero laminado en frío	Polvo	-
Base inferior	6	Piezas	1,2 mm. acero laminado en frío	Polvo	-
Espaciador	2	Piezas	-	-	Ancho de 800 mm.
Estante fijo	1	Piezas	1,2 mm. acero laminado en frío	Polvo	2 piezas para menos de 32u 1 pieza para menos de 22u
Ruedas	4	Piezas	-	-	-
Patas	4	Piezas	-	-	-
Tornillería	40	Sets	-	-	20 piezas para menos de 32u
Ventilador	4	Piezas	-	-	2 ventiladores en el modelo de 600 mm. de fondo
Regleta de 6 enchufes	1	Piezas	-	-	-
Llave	1	Piezas	-	-	-

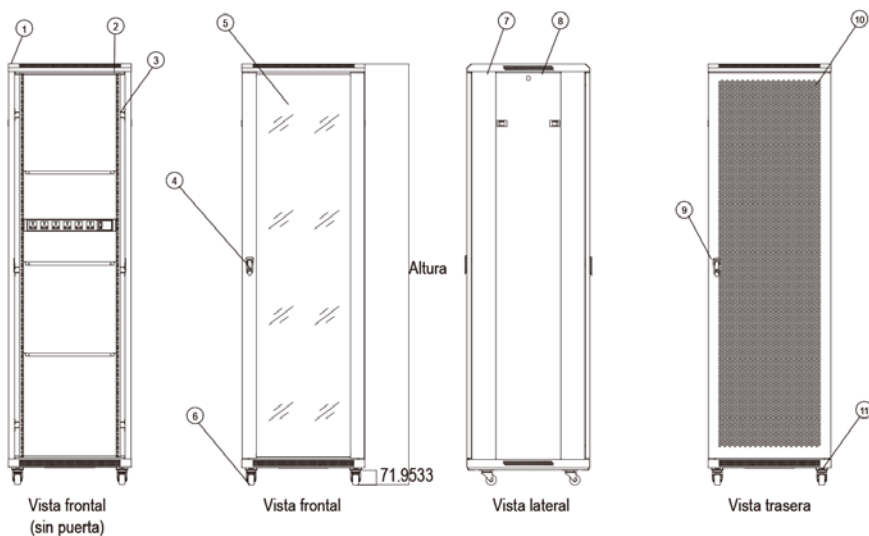
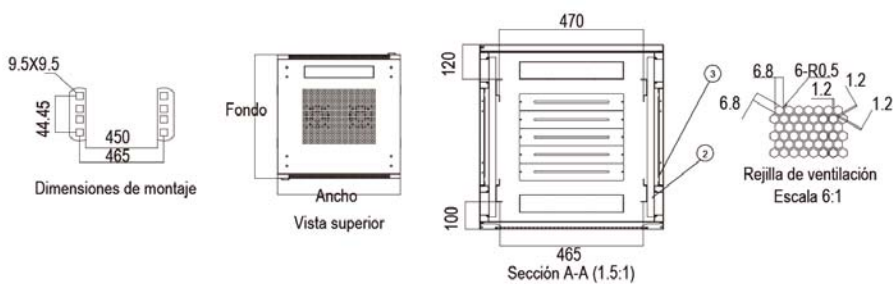
DESPIECE ESTRUCTURAL

1. Cubierta superior
2. Guía de montaje
3. Ángulo de montaje
4. Cerradura
5. Puerta frontal
6. Ruedas
7. Marco
8. Lateral
9. Cerradura
10. Puerta metálica perforada
11. Base inferior

RACK SERIE RCE



- Cumple con ANSI/EIA, RS-310-D, DIN41491; PART1, IEC297-2, DIN41494; PART7, GB/T3047.2-92
- Compatible con los estándares de 19".
- Diseño robusto y moderno de dimensiones precisas.
- Patas regulables en altura y ruedas con freno.
- Carga máxima: 300 kg.
- Entrada de cableado superior e inferior con posibilidad de cierre y ajuste.
- Puerta delantera y trasera que permiten una perfecta ventilación y un funcionamiento fiable.
- Panel lateral de fácil montaje.
- Gama completa de accesorios.

Referencia	Descripción
RCE1866	Rack 19" 18U 600x600 mm. delantera cristal y trasera ciega
RCE2266	Rack 19" 22U 600x600 mm. delantera cristal y trasera ciega
RCE2766	Rack 19" 27U 600x600 mm. delantera cristal y trasera ciega
RCE3266	Rack 19" 32U 600x600 mm. delantera cristal y trasera ciega
RCE3766	Rack 19" 37U 600x600 mm. delantera cristal y trasera ciega
RCE4266	Rack 19" 42U 600x600 mm. delantera cristal y trasera ciega

DESPIECE ESTRUCTURAL

1. Cubierta superior
2. Guía de montaje
3. Ángulo de montaje
4. Cerradura
5. Puerta frontal
6. Ruedas
7. Marco
8. Lateral
9. Cerradura
10. Puerta trasera
11. Base inferior

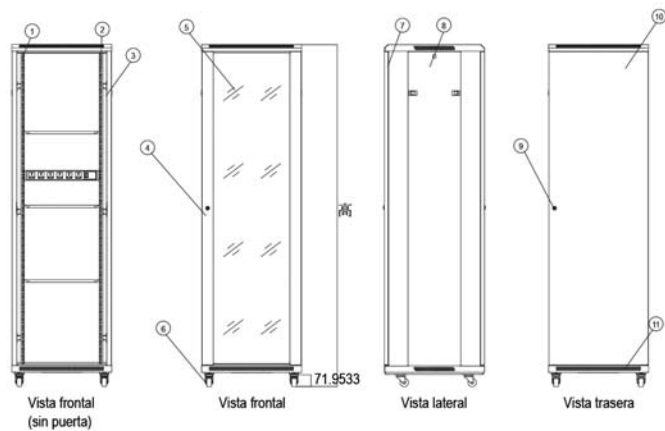

BASTIDORES LABORATORIO



- Cumple con ANSI/EIA, RS-310-D, DIN41491; PART1, IEC297-2, DIN41494; PART7, GB/T3047.2-92
- Compatible con ETSI y los estándares de 19".
- Diseño modular de fácil montaje, desmontaje y transporte.
- Bajo coste.
- Carga máxima: 150 kg.
- Nivel de protección: IP20.
- Gran gama de accesorios según las necesidades.

Referencia	Descripción
RB1866	Bastidor laboratorio 18U 600x600 mm.
RB2266	Bastidor laboratorio 22U 600x600 mm.
RB2766	Bastidor laboratorio 27U 600x600 mm.
RB3266	Bastidor laboratorio 32U 600x600 mm.
RB3766	Bastidor laboratorio 37U 600x600 mm.
RB4266	Bastidor laboratorio 42U 600x600 mm.
RB4766	Bastidor laboratorio 47U 600x600 mm.

DESPIECE ESTRUCTURAL

1. Bastidor
2. Base
3. Viga horizontal
4. Rueda

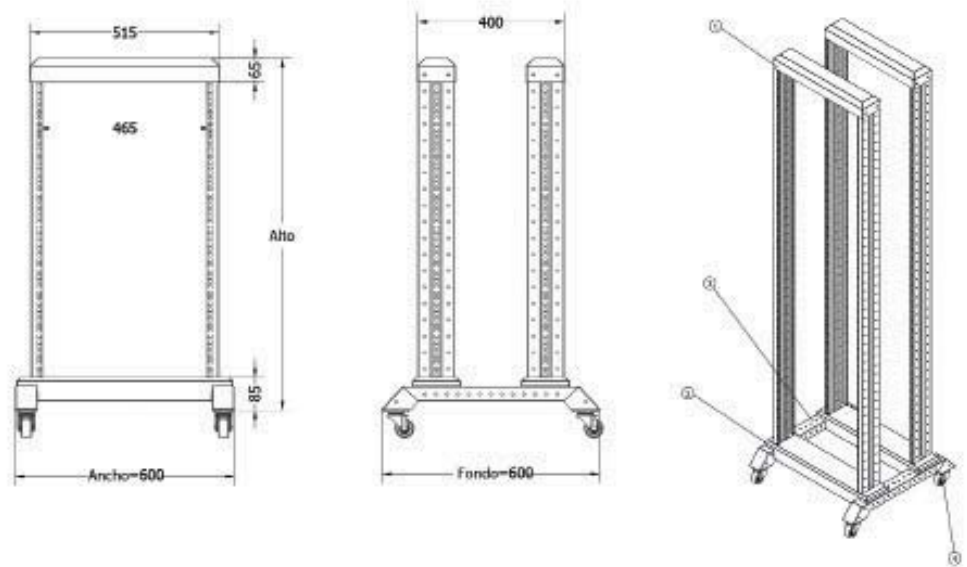

OPCIONES

Especificación	Cantidad	Unidades	Material	Acabado	Opciones
Bastidor	4	Piezas	1,2 mm. acero laminado en frío	Polvo	-
Base	2	Piezas	1,5 mm. acero laminado en frío	Polvo	-
Viga horizontal	2	Piezas	1,5 mm. acero laminado en frío	Polvo	-
Ruedas	4	Piezas	-	-	-
Tornillería	10	Sets	-	-	-
Llave	1	Piezas	-	-	-

COLD POOL SYSTEM FOR DATA CENTER



- Cumple con ANSI/EIA, RS-310-D, DIN41491; PART1, IEC297-2, DIN41494; PART7, GB/T3047.2-92
- Compatible con ETSI y los estándares de 19".
- Acabados: desengrasado, decapado, fosfórico, pintura en polvo.
- Cumple con RoHS.
- Puerta corredera de fácil apertura y cierre.
- Materiales: lámina de chapa de acero y cristal templado.
- Viga de soporte en la parte superior de 1,5 mm. de grosor.

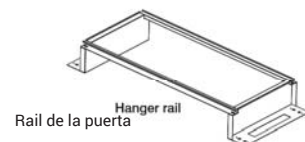
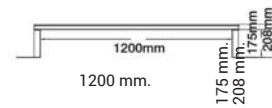
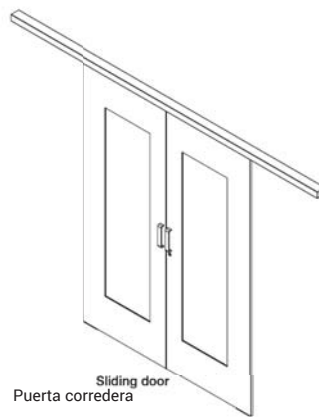
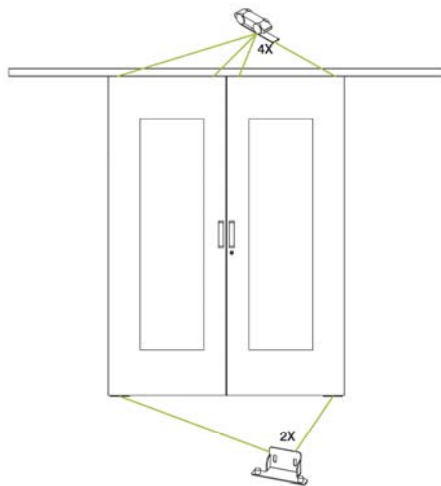
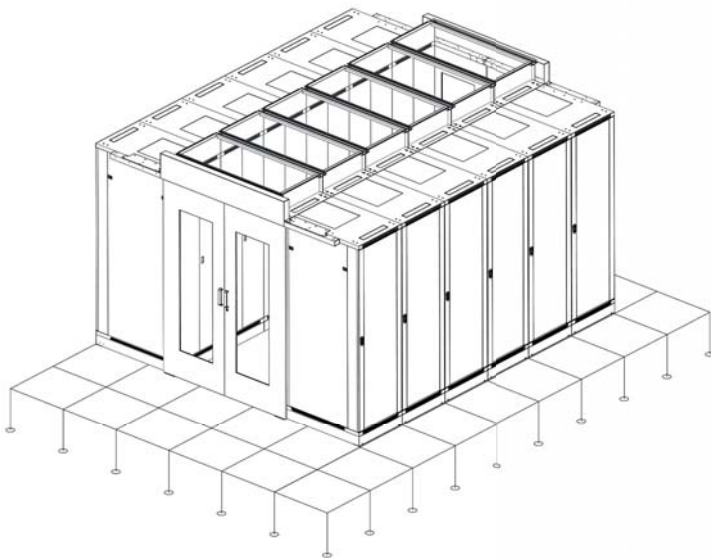

RACK PROTECCIÓN ELECTROMAGNÉTICA



- Cumple con el estándar GB12190-90 nivel C(FS-C).
- Campo magnético: 14KHz \geq 70dB; 150KHz \geq 95dB.
- Campo eléctrico: 200KHz ~1GHz \geq 100dB
- Onda plana: 50MHz ~ 1GHz \geq 100dB.
- Microondas: 1GHz ~10GHz \geq 95 dB.
- Nivel B(FS-B)150KHz~930MHz \geq 80 dB.
- Recinto hermético y puerta reforzada mediante soldadura con placa de acero laminado en frío.
- Acabado de la superficie: galvanizado, pintura en polvo y otro tratamiento anticorrosivo.
- Capacidad de evacuación de aire de cada ventilador: 1,4 m³ / min.
- Impide las interferencia de ondas electromagnéticas y previene la fuga de información.

Referencia	Descripción
NCS32765	Rack protección electromagnética 19" 32U 700x650 mm.
NCS37765	Rack protección electromagnética 19" 37U 700x650 mm.
NCS42765	Rack protección electromagnética 19" 42U 700x650 mm.

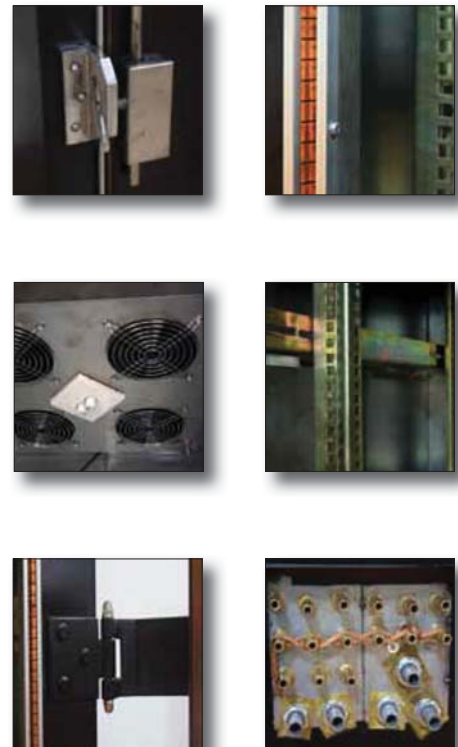
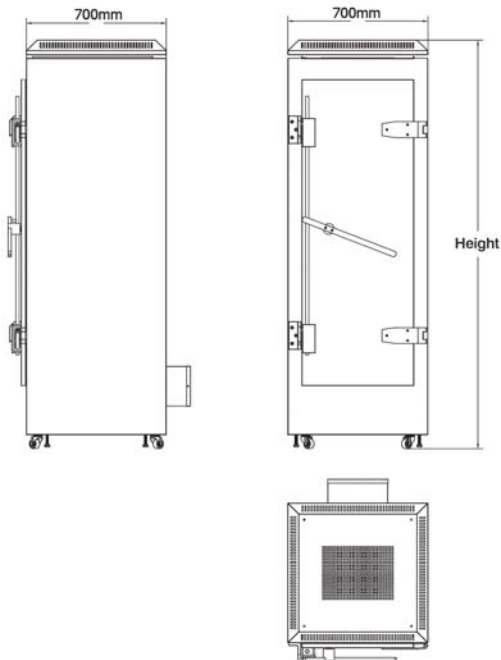

MURAL 1 CUERPO / MINI MURAL 10"



- Marco soldado y estructura sólida.
- Fácil montaje en la pared.
- Puerta frontal en cristal templado ahumado de 5 mm.
- Entrada de cable tanto en la tapa superior como en la base.
- Material principal: acero laminado en frío de 1,2 mm. de espesor.
- Vigas frontales y traseras en 1,5 mm.
- Acabados: desengrasado, dcapado, fosfórico y en polvo.
- Grado de protección: IP20.
- Carga máxima: 40kg.

Referencia	Descripción
RM11215B	Rack mural 19" 12U 1 cuerpo F-150 mm. RAL7044 beige
RM1123B	Rack mural 19" 12U 1 cuerpo F-300 mm. RAL7044 beige

- Fabricado en chapa de acero laminado en frío.
- Marco soldado y estructura sólida.
- Fácil montaje en la pared.
- Puerta frontal en cristal templado ahumado de 5 mm.
- Acabados: desengrasado, dcapado, fosfórico y en polvo.



Referencia	Descripción
RM106	Rack mini mural 10" 6U beige
RM106B	Rack mini mural 10" 6U negro
RM109	Rack mini mural 10" 9U beige
RM109B	Rack mini mural 10" 9U negro
RM112	Rack mini mural 10" 12U beige
RM112B	Rack mini mural 10" 12U negro



REGLETAS PARA RACK



Regleta 10" 1U 4 Schukos en PVC negro

Referencia B4T10



Regleta 19" 1U 4 Schukos sin interruptor en aluminio

Referencia B4T19A



Regleta 19" 1U 6 Schukos con interruptor en PVC negro

Referencia B6T19



Regleta 19" 1U 6 Schukos con interruptor en aluminio

Referencia B6T19A



Regleta 19" 1U 6 Schukos con magnetotérmico en PVC negro

Referencia B6TM19



Regleta 19" 1U 6 Schukos con magnetotérmico en aluminio

Referencia B6TM19A



Regleta 19" 1U 8 Schukos con protección contra sobretensiones en PVC negro

Referencia B8T19CP



Regleta 19" 1U 8 Schukos con protección contra sobretensiones en aluminio

Referencia B8T19CPA



Regleta 19" 1U 6 Schukos con diferencial en aluminio

Referencia B6TD19A



Regleta 19" 1U 5 Schukos (1maestra y 4 esclavas) en aluminio

Referencia B5TM519



**Regleta 19" 1U 8 Schukos
con interruptor en PVC negro**

Referencia B8TI19



**Regleta 19" 1U 8 Schukos
con interruptor en aluminio**

Referencia B8TI19A



**Regleta 19" 1U 8 Schukos
con piloto LED en aluminio**

Referencia B8TL19A



**Regleta 19" 1U 9 Schukos
en PVC negro**

Referencia B9TI19



**Regleta 19" 1U 9 Schukos
en aluminio**

Referencia B9TI19A



**Regleta 19" 1U 9 Schukos
con cable de 3m. en PVC negro**

Referencia B9TI193



**Regleta 19" 1U 9 Schukos
con piloto LED en PVC negro**

Referencia B9TL19



**Regleta 19" 1U 10 Schukos
con interruptor en aluminio**

Referencia B10TI19A



**Regleta 1U 12 Schukos
con piloto LED en aluminio**

Referencia B12TLPA



**Regleta 19" 1U 8 C13 + 1 C14
con interruptor en PVC negro**

Referencia B8TI19CA



**Regleta 19" 1U 12 C13 + 1 C14
con interruptor en PVC negro**

Referencia B12TIEC13



**Regleta 19" 1U 6 C19 + 1 C20
con interruptor en PVC negro**

Referencia B6TIEC19

ACCESORIOS PARA RACK

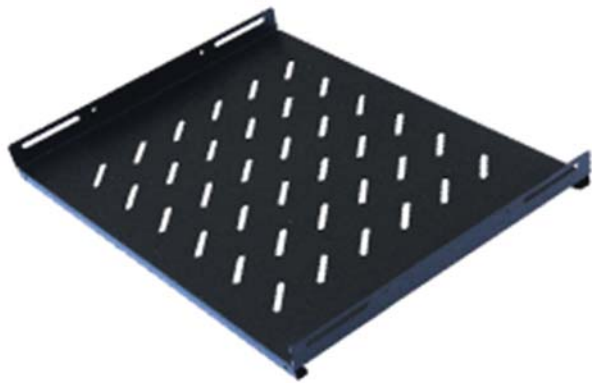

Bandejas fijas de 4 puntos

BF450	Bandeja fija 275 mm. 4 puntos F-450 mm.
BF600	Bandeja fija 350 mm. 4 puntos F-600 mm.
BF800	Bandeja fija 19" 2U 550 mm. 4 puntos F-800 mm.
BF800A	Bandeja fija 550 mm. 4 puntos fondo 800 carga pesada
BF1000	Bandeja fija 19" 2U 750 mm. 4 puntos F-1000 mm.
BF1000A	Bandeja fija 750 mm. 4 puntos fondo 1000 carga pesada

Bandejas de fijación frontal

B10F160	Bandeja fija 10" 1U F-160 mm.
B92180	Bandeja fija 19" 1U F-280 mm.
K30140	Bandeja fija 19" 1U F-400 mm.
K30228	Bandeja fija 19" 2U F-280 mm.
K30235	Bandeja fija 19" 2U F-350 mm.
K92400	Bandeja fija 19" 2U F-400 mm.
K30245	Bandeja fija 19" 2U F-450 mm.



Bandejas extensibles

BE35	Bandeja extensible 19" F-350 mm.
BE60	Bandeja extensible 19" F-600 mm.
BE80	Bandeja extensible 19" F-800 mm.
BE100	Bandeja extensible 19" F-1000 mm.

Anillas guíacables

AN6999911	Anilla guíacables acero inoxidable 40x40 mm.
AN6999912	Anilla guíacables acero inoxidable 40x80 mm.
AN6999913	Anilla guíacables acero inoxidable 80x80 mm.
AN6999914	Anilla guíacables acero inoxidable 80x120 mm.

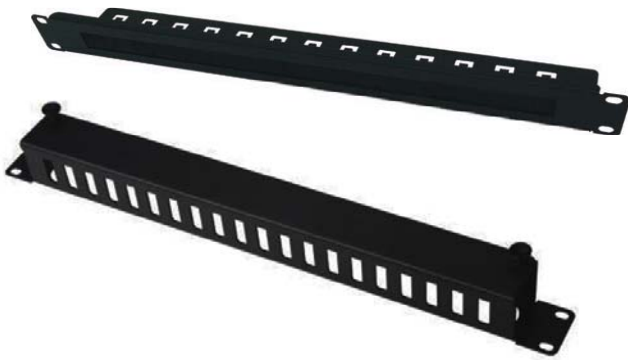

Pasacables con cepillo

PAC1	Panel pasacables 19" 1U con cepillo
PAC1/2	Panel pasacables 19" 1/2U con cepillo
PAC1B	Panel pasacables 19" 1U cepillo y bandeja
PAC2	Panel pasacables 19" 1U cepillo abierto
PAS7	Panel pasacables 19" 1U con tapa metal



Pasacables de liras metálicas

PAS03/5	Pasacables metálico 19" 1U 5 liras 5 cm.
PAS03/6	Pasacables metálico 19" 1U 5 liras 6 cm.
PAS03	Pasacables metálico 19" 1U 5 liras 7 cm.
PAS03C	Pasacables metálico 19" 1U 5 liras 7 cm. y cepillo
PAS05	Pasacables metálico 19" 2U 5 liras metal
PAS08	Pasacables metálico 19" 1U 5 liras (2 hor. y 3 vert.)



Pasacables vertical

K024342U	Guía pasacables vertical 42U
-----------------	------------------------------



Cajas diferenciales

CAJ6158	Caja diferenciales y servicios DIN gris
CAJ6158N	Caja diferenciales y servicios DIN negra



Paneles ranurados

PAR01	Panel ranurado 19" 1U
PAR02	Panel ranurado 19" 2U
PAR03	Panel ranurado 19" 3U
PAR04	Panel ranurado 19" 4U



Paneles ciegos

PACI01	Panel ciego 19" 1U
PACI02	Panel ciego 19" 2U
PACI03	Panel ciego 19" 3U
PACI04	Panel ciego 19" 4U



Panel ciego plástico

PACI05	Panel ciego en plástico 19" 1U
---------------	--------------------------------

ACCESORIOS PARA RACK



Ventilación

RT2VT	Unidad de ventilación 19" 2 ventiladores + termostato
RT4VT	Unidad de ventilación 19" 4 ventiladores + termostato
TERMO60	Termostato analógico 60°C
VEN02	Ventilador rack 120x120 mm.



Kits de tornillería

KT01	Kit de tornillería M6
KT01N	Kit de tornillería M6 negro
KT02	Kit de tornillería M6 (bolsa de 4 piezas)
KT025	Kit de tornillería M6 (bolsa de 25 piezas)



Cerraduras

C26102	Cerradura europea de armarios negra RAL9004
C26103	Cerradura europea de armarios niquelada
C26104	Cerradura con llave para armarios



Ruedas

KR01	Kit de ruedas para rack
KR02	Ruedas para rack
KR03	Ruedas con freno para rack



Patas

P01	Patas de regulación para rack
P02	Patas de regulación para rack de carga pesada



Conectores

KUB01	Kit de unión de racks en batería
--------------	----------------------------------

Fibra óptica

The background features a large, stylized number '47' in a light beige color. Thin, golden-brown lines radiate from various points, creating a sense of light or fiber optic paths. The overall color palette is warm, consisting of white, beige, and golden-brown tones.

LATIGUILLOS MULTIMODO 62.5/125 OM1-DÚPLEX



Latiguillo F.O. SC/SC 62.5/125 OM1 dúplex

Referencia LSCPSCPDM1x (longitud)
Longitudes 1 - 2 - 3 - 5 - 10 - 15 - 20 - 25 m.



Latiguillo F.O. ST/ST 62.5/125 OM1 dúplex

Referencia LSTPSTPDM1x (longitud)
Longitudes 1 - 2 - 3 - 5 - 10 - 15 - 20 - 25 m.



Latiguillo F.O. SC/ST 62.5/125 OM1 dúplex

Referencia LSCPSTPDM1x (longitud)
Longitudes 1 - 2 - 3 - 5 - 10 - 15 - 20 - 25 m.



Latiguillo F.O. LC/SC 62.5/125 OM1 dúplex

Referencia LLCPSCPDM1x (longitud)
Longitudes 1 - 2 - 3 - 5 - 10 - 15 - 20 - 25 m.



Latiguillo F.O. LC/ST 62.5/125 OM1 dúplex

Referencia LLCPSTPDM1x (longitud)
Longitudes 1 - 2 - 3 - 5 - 10 - 15 - 20 - 25 m.



Latiguillo F.O. LC/LC 62.5/125 OM1 dúplex

Referencia LLCPLCPDM1x (longitud)
Longitudes 1 - 2 - 3 - 5 - 10 - 15 - 20 - 25 m.

LATIGUILLOS MULTIMODO 50/125 OM2-DÚPLEX



Latiguillo F.O. SC/SC 50/125 OM2 dúplex

Referencia LSCPSCPDM2x (longitud)
Longitudes 1 - 2 - 3 - 5 - 10 - 15 - 20 - 25 m.



Latiguillo F.O. ST/ST 50/125 OM2 dúplex

Referencia LSTPSTPDM2x (longitud)
Longitudes 1 - 2 - 3 - 5 - 10 - 15 - 20 - 25 m.



Latiguillo F.O. SC/ST 50/125 OM2 dúplex

Referencia LSCPSTPDM2x (longitud)
Longitudes 1 - 2 - 3 - 5 - 10 - 15 - 20 - 25 m.



Latiguillo F.O. LC/SC 50/125 OM2 dúplex

Referencia LLCPSCPDM2x (longitud)
Longitudes 1 - 2 - 3 - 5 - 10 - 15 - 20 - 25 m.



Latiguillo F.O. LC/ST 50/125 OM2 dúplex

Referencia LLCPSTPDM2x (longitud)
Longitudes 1 - 2 - 3 - 5 - 10 - 15 - 20 - 25 m.



Latiguillo F.O. LC/LC 50/125 OM2 dúplex

Referencia LLCPLCPDM2x (longitud)
Longitudes 1 - 2 - 3 - 5 - 10 - 15 - 20 - 25 m.

LATIGUILLOS MULTIMODO 50/125 OM3-DÚPLEX



Latiguillo F.O. SC/SC 50/125 OM3 dúplex

Referencia LSCPSCPDM3x (longitud)
Longitudes 1 - 2 - 3 - 5 - 10 - 15 - 20 - 25 m.



Latiguillo F.O. ST/ST 50/125 OM3 dúplex

Referencia LSTPSTPDM3x (longitud)
Longitudes 1 - 2 - 3 - 5 - 10 - 15 - 20 - 25 m.



Latiguillo F.O. SC/ST 50/125 OM3 dúplex

Referencia LSCPSTPDM3x (longitud)
Longitudes 1 - 2 - 3 - 5 - 10 - 15 - 20 - 25 m.



Latiguillo F.O. LC/SC 50/125 OM3 dúplex

Referencia LLCPSCPDM3x (longitud)
Longitudes 1 - 2 - 3 - 5 - 10 - 15 - 20 - 25 m.



Latiguillo F.O. LC/ST 50/125 OM3 dúplex

Referencia LLCPSTPDM3x (longitud)
Longitudes 1 - 2 - 3 - 5 - 10 - 15 - 20 - 25 m.



Latiguillo F.O. LC/LC 50/125 OM3 dúplex

Referencia LLCPLCPDM3x (longitud)
Longitudes 1 - 2 - 3 - 5 - 10 - 15 - 20 - 25 m.

LATIGUILLOS MULTIMODO 50/125 OM4-DÚPLEX

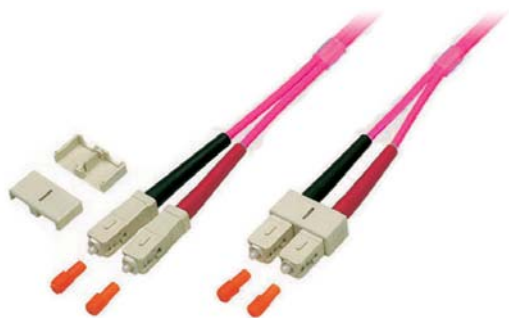

Latiguillo F.O. SC/SC 50/125 OM4 dúplex

Referencia LSCPSCPDM4x (longitud)

Longitudes 1 - 2 - 3 - 5 - 10 - 15 - 20 - 25 m.



Latiguillo F.O. ST/ST 50/125 OM4 dúplex

Referencia LSTPSTPDM4x (longitud)

Longitudes 1 - 2 - 3 - 5 - 10 - 15 - 20 - 25 m.



Latiguillo F.O. SC/ST 50/125 OM4 dúplex

Referencia LSCPSTPDM4x (longitud)

Longitudes 1 - 2 - 3 - 5 - 10 - 15 - 20 - 25 m.



Latiguillo F.O. LC/SC 50/125 OM4 dúplex

Referencia LLCSCPDM4x (longitud)

Longitudes 1 - 2 - 3 - 5 - 10 - 15 - 20 - 25 m.



Latiguillo F.O. LC/ST 50/125 OM4 dúplex

Referencia LLCSTPDM4x (longitud)

Longitudes 1 - 2 - 3 - 5 - 10 - 15 - 20 - 25 m.



Latiguillo F.O. LC/LC 50/125 OM4 dúplex

Referencia LLCPLCPDM4x (longitud)

Longitudes 1 - 2 - 3 - 5 - 10 - 15 - 20 - 25 m.

LATIGUILLOS MONOMODO 9/125 OS2-SIMPLEX/DÚPLEX

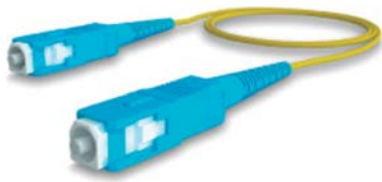

Latiguillo F.O. SC-UPC/SC-UPC 9/125 OS2 simplex

Referencia LSCUSCUSS2x (longitud)
Longitudes 1 - 2 - 3 - 5 - 10 - 15 - 20 - 25 m.



Latiguillo F.O. LC-UPC/SC-UPC 9/125 OS2 simplex

Referencia LLCUSCUSS2x (longitud)
Longitudes 1 - 2 - 3 - 5 - 10 - 15 - 20 - 25 m.



Latiguillo F.O. LC-UPC/SC-APC 9/125 OS2 simplex

Referencia LLCUSCASS2x (longitud)
Longitudes 1 - 2 - 3 - 5 - 10 - 15 - 20 - 25 m.



Latiguillo F.O. SC-UPC/SC-UPC 9/125 OS2 dúplex

Referencia LSCUSCUDS2x (longitud)
Longitudes 1 - 2 - 3 - 5 - 10 - 15 - 20 - 25 m.



Latiguillo F.O. ST-UPC/ST-UPC 9/125 OS2 dúplex

Referencia LSTUSTUDS2x (longitud)
Longitudes 1 - 2 - 3 - 5 - 10 - 15 - 20 - 25 m.



Latiguillo F.O. ST-UPC/SC-UPC 9/125 OS2 dúplex

Referencia LSTUSCUDS2x (longitud)
Longitudes 1 - 2 - 3 - 5 - 10 - 15 - 20 - 25 m.



Latiguillo F.O. LC-UPC/SC-UPC 9/125 OS2 dúplex

Referencia LLCUSCUDS2x (longitud)
Longitudes 1 - 2 - 3 - 5 - 10 - 15 - 20 - 25 m.



Latiguillo F.O. LC-UPC/ST-UPC 9/125 OS2 dúplex

Referencia LLCUSTUDS2x (longitud)
Longitudes 1 - 2 - 3 - 5 - 10 - 15 - 20 - 25 m.

LATIGUILLOS MONOMODO 9/125 OS2-DÚPLEX / PIG TAILS



Latiguillo F.O. LC-UPC/SC-APC 9/125 OS2 dúplex

Referencia	LLCUSCADS2x (longitud)
Longitudes	1 - 2 - 3 - 5 - 10 - 15 - 20 - 25 m.



Latiguillo F.O. LC-UPC/LC-UPC 9/125 OS2 dúplex

Referencia	LLCULCUDS2x (longitud)
Longitudes	1 - 2 - 3 - 5 - 10 - 15 - 20 - 25 m.



Pig Tails FC

PFCAS2	Pig-tail FC-APC SM 9/125 OS2
PFCPM2	Pig-tail FC MM 50/125 OM2
PFCPM3	Pig-tail FC MM 50/125 OM3



Pig Tails SC

PSCAS2	Pig-tail SC-APC SM 9/125 OS2
PSCPM1	Pig-tail SC MM 62.5/125 OM1
PSCPM2	Pig-tail SC MM 50/125 OM2
PSCPM3	Pig-tail SC MM 50/125 OM3
PSCPM4	Pig-tail SC MM 50/125 OM4



Pig Tails LC

PLCAS2	Pig-tail LC-APC SM 9/125 OS2
PLCPM1	Pig-tail LC MM 62.5/125 OM1
PLCPM2	Pig-tail LC MM 50/125 OM2
PLCPM3	Pig-tail LC MM 50/125 OM3
PLCPM4	Pig-tail LC MM 50/125 OM4
PLCUS2	Pig-tail LC-UPC SM 9/125 OS2



Pig Tails ST

PSTPM1	Pig-tail ST MM 62.5/125 OM1
PSTPM2	Pig-tail ST MM 50/125 OM2
PSTPM3	Pig-tail ST MM 50/125 OM3
PSTPM4	Pig-tail ST MM 50/125 OM4
PSTPS2	Pig-tail ST-PC SM 9/125 OS2
PSTUS2	Pig-tail ST-UPC SM 9/125 OS2

CONECTORES / ATENUADORES



Conectores LC-PC

- CNLCPA** Conector LC-PC simplex 3 mm.
- CNLCPB** Conector LC-PC simplex 900 um.
- CNLCPC** Conector LC-PC simplex 2 mm.



Conectores LC-UPC

- CNLCUA** Conector LC-UPC simplex 3 mm.
- CNLCUB** Conector LC-UPC simplex 900 um.
- CNLCUC** Conector LC-UPC simplex 2 mm.



Conectores SC-PC

- CNSCPA** Conector SC-PC simplex 3 mm.
- CNSCPB** Conector SC-PC simplex 900 um.
- CNSCPC** Conector SC-PC simplex 2 mm.



Conectores SC-APC

- CNSCAA** Conector SC-APC simplex 3 mm.
- CNSCAB** Conector SC-APC simplex 900 um.
- CNSCAC** Conector SC-APC simplex 2 mm.



Conectores ST-PC

- CNSTPA** Conector ST-PC simplex 3 mm.
- CNSTPB** Conector ST-PC simplex 900 um.
- CNSTPC** Conector ST-PC simplex 2 mm.



Conectores ST-UPC

- CNSTUA** Conector ST-UPC simplex 3 mm.
- CNSTUB** Conector ST-UPC simplex 900 um.
- CNSTUC** Conector ST-UPC simplex 2 mm.



Atenuador LC-UPC SM fijo

- Referencia** ATLCUx (atenuación)
- Atenuación** 5 - 10 - 15 - 20 dB



Atenuador SC-APC SM fijo

- Referencia** ATSCAx (atenuación)
- Atenuación** 1 - 2 - 3 - 4 - 5 - 6 dB



Atenuador SC-UPC SM fijo

- Referencia** ATSCUx (atenuación)
- Atenuación** 5 - 10 - 15 - 20 dB



Adaptadores LC-PC

- ADLCPSM1** *Adaptador LC-PC simplex multimodo OM1*
- ADLCPDM1** *Adaptador LC-PC dúplex multimodo OM1*



Adaptadores LC-UPC

- ADLCUSS1** *Adaptador LC-UPC simplex monomodo OS1*
- ADLCUDS1** *Adaptador LC-UPC dúplex monomodo OS1*



Adaptadores SC-PC

- ADSCPSM1** *Adaptador SC-PC simplex monomodo OM1*
- ADSCPDM1** *Adaptador SC-PC dúplex multimodo OM1*



Adaptadores SC-APC

- ADSCASS1** *Adaptador SC-APC simplex monomodo OS1*
- ADSCADS1** *Adaptador SC-APC dúplex monomodo OS1*



Adaptadores SC-UPC

- ADSCUSS1** *Adaptador SC-UPC simplex monomodo OS1*
- ADSCUDS1** *Adaptador SC-UPC dúplex monomodo OS1*



Referencia	Descripción
ADSTPSCPSS1	<i>Adaptador ST-PC/SC-PC simplex monomodo</i>
ADSTPSCPDS1	<i>Adaptador ST-PC/SC-PC dúplex monomodo</i>
ADSTPSCPDM1	<i>Adaptador ST-PC/SC-PC dúplex multimodo</i>



Adaptadores ST-PC

- ADSTPSS1** *Adaptador ST-PC simplex monomodo OS1*
- ADSTPSM1** *Adaptador ST-PC simplex multimodo OM1*

ACCESORIOS



Referencia	Descripción
RME72F	Armario mural FTTH empalme/reparto 72 fibras



Referencia	Descripción
CAE8F	Caja de empalme FTTH 8 fibras



Referencia	Descripción
CAE16F	Caja de empalme FTTH 16 fibras



Referencia	Descripción
PAU1F	PAU fibra 2 salidas SC simplex / LC dúplex



Referencia	Descripción
PAU2F	PAU fibra 1 salida SC dúplex



Referencia	Descripción
PAU4F	PAU fibra 4 salidas SC simplex



Referencia	Descripción
B1USFN	Bandeja 19" 1U extensible con cassette + prensa negra



Referencia	Descripción
E530251	Tapón F.O. FC / ST (A)
E530281	Tapón F.O. SC dúplex (B)
E530301	Tapón F.O. SC simplex / LC dúplex (C)
462794	Cierres por presión 1.9-4.2 T 1 (D)



Referencia	Descripción
F12ST	Frontal 19" 1U 12P ST vacío



Referencia	Descripción
F24ST	Frontal 19" 1U 24P ST vacío



Referencia	Descripción
F12SCS	Frontal 19" 1U 12P SC simple vacío



Referencia	Descripción
F24SCS	Frontal 19" 1U 24P SC simple vacío



Referencia	Descripción
F12SCD	Frontal 19" 1U 12P SC doble vacío



Referencia	Descripción
F24SCD	Frontal 19" 1U 24P SC doble vacío

ACCESORIOS



Referencia	Descripción
CNSCAM	Conector SC-APC simplex empalme mecánico (A)
CNSCUM	Conector SC-UPC simplex empalme mecánico (B)



Referencia	Descripción
EMPMEC	Empalme mecánico F.O.

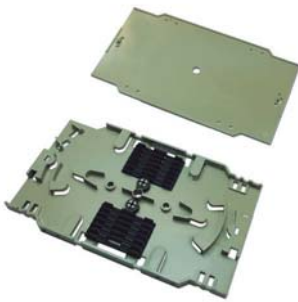

Referencia	Descripción
C53012	Cassette de F.O. 2 peines 2x6 fibras



Referencia	Descripción
C53013	Cassette de F.O. 2 peines 2x12 fibras



Referencia	Descripción
MAFAZ	Manguito de 900um FC azul
MAFCB	Manguito de 900um FC beige



Referencia	Descripción
MASCAZ	Manguito de 900um SC azul
MASCB	Manguito de 900um SC beige
MASCV	Manguito de 900um SC-APC verde



Referencia	Descripción
MASTA	Manguito de 900um ST amarillo
MASTN	Manguito de 900um ST negro



Referencia	Descripción
PUSCAZ	Pieza de unión SC azul
PUSCB	Pieza de unión SC beige



Referencia	Descripción
PTRF002	Protector de fusión F.O. 40 mm.
PTRF001	Protector de fusión F.O. 60 mm.

Informática

The background features a large, stylized purple graphic element resembling a letter 'A' or a similar shape, composed of thick, curved lines. This shape is set against a white background with several thin, purple lines that converge and diverge, creating a sense of depth and movement. The overall aesthetic is modern and technical.

CABLES USB 2.0



Cable USB 2.0 Premium tipo A M / tipo B M negro

Referencia CAB5256x (longitud)

Longitudes 0.5 - 1 - 1.5 - 1.8 - 3 - 5 m.



Cable USB 2.0 mejorado tipo A 90° M / tipo B M negro

Referencia CAB5245x (longitud)

Longitudes 0.5 - 1 - 1.5 - 1.8 - 3 - 5 m.

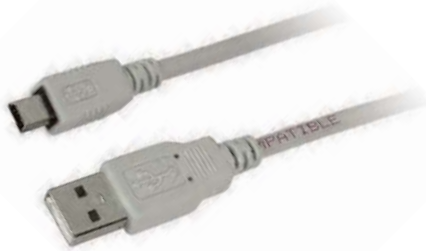

Cable USB 2.0 mejorado tipo A M / mini USB tipo B M gris

Referencia CAB5250GRx (longitud)

Longitudes 0.5 - 1 - 1.5 - 1.8 - 3 - 5 m.



Cable USB 2.0 mejorado tipo A M / mini USB tipo B M negro

Referencia CAB5250Nx (longitud)

Longitudes 0.5 - 1 - 1.5 - 1.8 - 3 - 5 m.

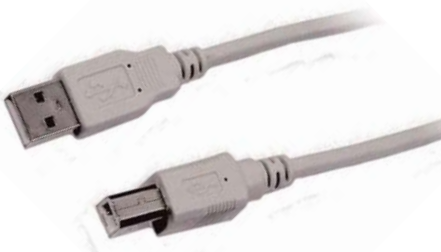

Cable USB 2.0 mejorado tipo A M / tipo B M gris

Referencia CAB5255GRx (longitud)

Longitudes 0.5 - 1 - 1.5 - 1.8 - 3 - 5 m.



Cable USB 2.0 mejorado tipo A M / tipo B M negro

Referencia CAB5255Nx (longitud)

Longitudes 0.5 - 1 - 1.5 - 1.8 - 3 - 5 m.



Cable USB 2.0 mejorado tipo A M/M negro

Referencia CAB5253x (longitud)

Longitudes 0.5 - 1 - 1.5 - 1.8 - 3 - 5 m.



Cable USB 2.0 standard tipo A 90° M/H negro

Referencia CAB5239x (longitud)

Longitudes 0.5 - 1 - 1.5 - 1.8 - 3 - 5 m.



Cable USB 2.0 standard tipo A 90° M / tipo B M negro

Referencia CAB5238x (longitud)
Longitudes 0.5 - 1 - 1.5 - 1.8 - 3 - 5 m.



Cable USB 2.0 standard tipo A M / micro USB tipo B M negro

Referencia CAB5228x (longitud)
Longitudes 0.5 - 1 - 1.5 - 1.8 - 3 - 5 m.

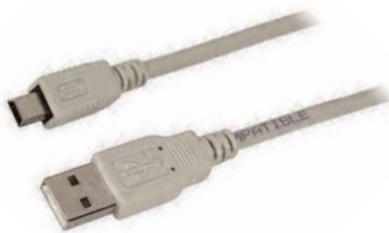

Cable USB 2.0 standard tipo A M / mini USB tipo B M gris

Referencia CAB5224GRx (longitud)
Longitudes 0.5 - 1 - 1.5 - 1.8 - 3 - 5 m.



Cable USB 2.0 standard tipo A M / mini USB tipo B M negro

Referencia CAB5224Nx (longitud)
Longitudes 0.5 - 1 - 1.5 - 1.8 - 3 - 5 m.



Cable USB 2.0 standard tipo A M/M negro

Referencia CAB5225x (longitud)
Longitudes 0.5 - 1 - 1.5 - 1.8 - 3 - 5 m.



Cable USB 2.0 standard tipo A M / tipo B 90° M negro

Referencia CAB5241x (longitud)
Longitudes 0.5 - 1 - 1.5 - 1.8 - 3 - 5 m.

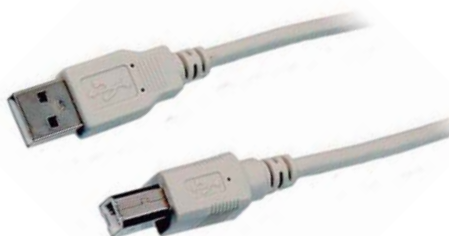

Cable USB 2.0 standard tipo A M / tipo B M gris

Referencia CAB5219GRx (longitud)
Longitudes 0.5 - 1 - 1.5 - 1.8 - 3 - 5 m.



Cable USB 2.0 standard tipo A M / tipo B M negro

Referencia CAB5219Nx (longitud)
Longitudes 0.5 - 1 - 1.5 - 1.8 - 3 - 5 m.

CABLES USB 3.0



Cable USB 3.0 Premium tipo A M/M azul

Referencia CAB5210AZx (longitud)

Longitudes 1 - 1.8 - 3 - 5 m.



Cable USB 3.0 Premium tipo A M/M negro

Referencia CAB5210Nx (longitud)

Longitudes 1 - 1.8 - 3 - 5 m.



Cable USB 3.0 Premium tipo A M / tipo B M azul

Referencia CAB5236AZx (longitud)

Longitudes 1 - 1.8 - 3 - 5 m.



Cable USB 3.0 Premium tipo A M / tipo B M negro

Referencia CAB5236Nx (longitud)

Longitudes 1 - 1.8 - 3 - 5 m.



Cable USB 3.0 mejorado tipo A M / micro USB tipo B M azul

Referencia CAB5295AZx (longitud)

Longitudes 1 - 1.8 - 3 - 5 m.



Cable USB 3.0 mejorado tipo A M / micro USB tipo B M negro

Referencia CAB5295Nx (longitud)

Longitudes 1 - 1.8 - 3 - 5 m.



Cable USB 3.0 mejorado tipo A M/M azul

Referencia CAB5280AZx (longitud)

Longitudes 1 - 1.8 - 3 - 5 m.



Cable USB 3.0 mejorado tipo A M/M negro

Referencia CAB5280Nx (longitud)

Longitudes 1 - 1.8 - 3 - 5 m.



Cable USB 3.0 mejorado tipo A M / tipo B M azul

Referencia CAB5247AZx (longitud)

Longitudes 1 - 1.8 - 3 - 5 m.



Cable USB 3.0 mejorado tipo A M / tipo B M negro

Referencia CAB5247Nx (longitud)

Longitudes 1 - 1.8 - 3 - 5 m.

CABLES EXTENSORES USB 2.0 / 3.0



Cable extensor USB 2.0 Premium tipo A M/H negro

Referencia CAB5220x (longitud)
Longitudes 0.5 - 1 - 1.5 - 1.8 - 3 - 5 m.



Cable extensor USB 2.0 mejorado tipo A 90° M/H negro

Referencia CAB5246x (longitud)
Longitudes 0.5 - 1 - 1.5 - 1.8 - 3 - 5 m.

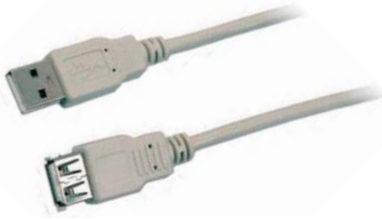

Cable extensor USB 2.0 mejorado tipo A M/H gris

Referencia CAB5248GRx (longitud)
Longitudes 0.5 - 1 - 1.5 - 1.8 - 3 - 5 m.



Cable extensor USB 2.0 mejorado tipo A M/H negro

Referencia CAB5248Nx (longitud)
Longitudes 0.5 - 1 - 1.5 - 1.8 - 3 - 5 m.

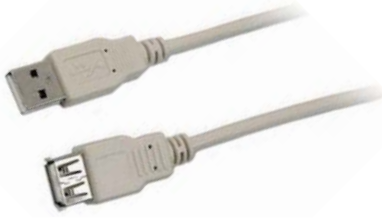

Cable extensor USB 2.0 standard tipo A M/H gris

Referencia CAB5221GRx (longitud)
Longitudes 0.5 - 1 - 1.5 - 1.8 - 3 - 5 m.



Cable extensor USB 2.0 standard tipo A M/H negro

Referencia CAB5221Nx (longitud)
Longitudes 0.5 - 1 - 1.5 - 1.8 - 3 - 5 m.



Cable extensor USB 3.0 Premium tipo A M/H azul

Referencia CAB5237AZx (longitud)
Longitudes 1 - 1.8 - 3 - 5 m.



Cable extensor USB 3.0 Premium tipo A M/H negro

Referencia CAB5237Nx (longitud)
Longitudes 1 - 1.8 - 3 - 5 m.



Cable extensor USB 3.0 mejorado tipo A M/H negro

Referencia CAB5268Nx (longitud)
Longitudes 1 - 1.8 - 3 - 5 m.



Cable extensor USB 3.0 mejorado tipo A M/H azul

Referencia CAB5268AZx (longitud)
Longitudes 1 - 1.8 - 3 - 5 m.

ADAPTADORES / CABLES SUB D



Referencia	Descripción
ADPS2HH	Adaptador mini DIN PS2 H/H



Adaptadores sub D 9

AD409	Adaptador sub D 9 M/H
AD410	Adaptador sub D 9 M/M
AD411	Adaptador sub D 9 H/H



Adaptadores sub D 15

AD420	Adaptador sub D 15 H/H HD
AD421	Adaptador sub D 15P M/M HD
AD480	Adaptador sub D 15 H / 9 M



Adaptadores sub D 25

AD414	Adaptador sub D 25 M/M
AD414A	Adaptador sub D 25 M/H
AD415	Adaptador sub D 25 H/H



Cables sub D 25 M/H

CAB25MH2	Cable sub D 25 M/H 1,8 m.
CAB25MH3	Cable sub D 25 M/H 3 m.
CAB25MH5	Cable sub D 25 M/H 5 m.
CAB25MH10	Cable sub D 25 M/H 10 m.



Cables sub D 25 M/M

CAB25MM1.8	Cable sub D 25 M/M 1,8 m.
CAB25MM3	Cable sub D 25 M/M 3 m. moldeado
CAB25MM5	Cable sub D 25 M/M 5 m.
CAB25MM10	Cable sub D 25 M/M 10 m.



Referencia	Descripción
CAB9HH2	Cable Sub D 9 H/H 2 m.



Referencia	Descripción
CAB9MH2	Cable Sub D 9P M/H 2 m.



Referencia	Descripción
CAB9MM2	Cable Sub D 9 M/M 2 m.



Referencia	Descripción
AD441	Adaptador USB 2.0 tipo A M / tipo A M



Referencia	Descripción
AD442	Adaptador USB 2.0 tipo A H / tipo A H



Referencia	Descripción
AD443	Adaptador USB 2.0 tipo A H / tipo B M



Referencia	Descripción
AD541	Adaptador USB 2.0 tipo A M / tipo B H



Referencia	Descripción
AD542	Adaptador USB 2.0 tipo A H / tipo B H



Referencia	Descripción
AD543	Adaptador USB 2.0 tipo A H / micro USB tipo B M



Referencia	Descripción
AD544	Adaptador USB 3.0 tipo A M / tipo B H



Referencia	Descripción
AD545	Adaptador USB 3.0 tipo A H / tipo A H



Referencia	Descripción
AD546	Adaptador USB 3.0 tipo A H / tipo B M



Referencia	Descripción
AD547	Adaptador USB 3.0 tipo A H / tipo B H



Referencia	Descripción
AD549	Adaptador USB 3.0 tipo B H / micro USB tipo B M



Referencia	Descripción
AD550	Adaptador USB 3.0 tipo A H / micro USB tipo B M



Referencia	Descripción
AD439	Adaptador USB tipo A H / mini DIN 6P M



Referencia	Descripción
AD5804	Adaptador USB tipo A H / mini DIN 6P M



Referencia	Descripción
AD5805	Adaptador USB tipo A M / mini DIN 6 H



Referencia	Descripción
CABPT2	Cable mini DIN 6 M/H 2 m.
CABPTA2	Cable mini DIN 6 M/M 2 m.



Referencia	Descripción
CAB5307	Cable adaptador USB tipo A M / mini DIN 6 H 0,2 m.



Referencia	Descripción
EBUSB451	Adaptador con cable USB tipo A M / ex PS/2 H 0,2 m.

COMPONENTES USB



Referencia **Descripción**

CAB529105 Cable extensor USB 2.0 para montaje tipo A M/H 0,5 m.

CAB52913 Cable extensor USB 2.0 para montaje tipo A M/H 3 m.



Referencia **Descripción**

CAB529305 Cable extensor USB 2.0 para montaje tipo B M/H 0,5 m.

CAB52931.8 Cable extensor USB 2.0 para montaje tipo B M/H 1,8 m.

CAB52933 Cable extensor USB 2.0 para montaje tipo B M/H 3 m.



Referencia **Descripción**

CAB52635 Cable prolongador USB 2.0 amplificado 5 m.

CAB52638 Cable prolongador USB 2.0 amplificado 8 m.



Referencia **Descripción**

AD438 Adaptador extensor USB 2.0 tipo A M / 2x tipo A H 1,5 m.



Referencia **Descripción**

AD853A Adaptador USB 1.1 tipo A M / RS-232 M 1,8 m.

AD853B Adaptador USB 2.0 tipo A M / RS-232 M 1,8 m.



Referencia **Descripción**

CAB53050.2 Cable USB interno para controladora de ordenador 0,2 m.



Referencia **Descripción**

AD457 Adaptador USB 3.0 tipo A M / eSATA II 0,3 m.



Referencia **Descripción**

EBUSB200 Estación de acoplamiento de discos duros



Referencia **Descripción**

UCE60 Transmisor y receptor USB 1.1 vía RJ45



Referencia **Descripción**

EBUSBCARD101 Lector de tarjetas USB 2.0



Referencia **Descripción**

AD200 Adaptador USB 2.0 tipo A M / RJ45 H



Referencia **Descripción**

EBUSB453 Convertidor IDE / SATA

Audio / Vídeo

The background features a large, light teal number '4' on the right side. From the left edge, several thin teal lines converge towards the center and then fan out towards the right, passing behind the '4'. At the bottom, there are several overlapping, curved teal shapes in various shades, creating a layered, wave-like effect.

CABLES HDMI



Cable HDMI tipo A M / mini HDMI tipo D M

Referencia CAB5410x (longitud)

Longitudes 1 - 2 - 3 - 5 m.



Cable HDMI tipo A M / mini HDMI tipo C M

Referencia CAB5428x (longitud)

Longitudes 1 - 2 - 3 - 5 m.



Cable HDMI tipo A M/M blanco

Referencia CAB5431xB (longitud)

Longitudes 1 - 2 - 3 - 5 m.



Cable HDMI tipo A M/M negro

Referencia CAB5431xN (longitud)

Longitudes 1 - 2 - 3 - 5 - 10 - 15 - 20 m.



Cable mini HDMI tipo C M/M

Referencia CAB5429x (longitud)

Longitudes 1 - 2 - 3 - 5 m.



Cable HDMI tipo A M / DVI 18+1 M

Referencia CAB5432x (longitud)

Longitudes 2 - 3 - 5 - 10 - 15 - 20 m.



Cable HDMI plano tipo A M/M blanco

Referencia CAB7901xB (longitud)

Longitudes 1 - 2 - 3 - 5 m.



Cable HDMI plano tipo A M/M negro

Referencia CAB7901xN (longitud)

Longitudes 1 - 2 - 3 - 5 m.



Cable HDMI tipo A M/M regulable 90° a 180°

Referencia CAB7902x (longitud)
Longitudes 1 - 2 - 3 - 5 m.



Cable extensor HDMI tipo A M/H

Referencia CAB7903x (longitud)
Longitudes 1 - 2 - 3 - 5 m.



Cable HDMI tipo A M/M con ferrita

Referencia CAB7904x (longitud)
Longitudes 1 - 2 - 3 - 5 m.



Adaptadores HDMI regulables 90° a 180°

AD477 Adaptador HDMI M/H regulable 90° a 180°
AD478 Adaptador HDMI H/H regulable 90° a 180°



Referencia AD470
Descripción Adaptador HDMI tipo A M / DVI-D 24+1 H



Referencia AD471
Descripción Adaptador HDMI tipo A H / DVI-D 24+1 M



Referencia AD472
Descripción Adaptador HDMI tipo A H / H



Referencia AD473
Descripción Adaptador HDMI tipo A M / H 90°



Referencia AD474
Descripción Adaptador HDMI tipo C M / HDMI tipo A H



Referencia AD475
Descripción Adaptador HDMI tipo A M / H

DISPLAYPORT / VGA / DVI



Cable DVI-D 18+1 M/M

Referencia CAB5433x (longitud)
Longitudes 2 - 3 - 5 - 10 - 15 - 20 m.



Cable DVI-D 24+1 M/M

Referencia CAB5434x (longitud)
Longitudes 2 - 3 - 5 - 10 - 15 - 20 m.



Cable DVI-A 12+5 M / VGA M

Referencia CAB5436x (longitud)
Longitudes 2 - 3 - 5 m.



Cable DisplayPort M/M

Referencia CAB5560x (longitud)
Longitudes 1,8 - 3 - 5 m.



Cable SVGA M/M alta calidad con ferrita

Referencia CABV1x (longitud)
Longitudes 1,8 - 3 - 5 - 10 - 15 - 20 - 25 m.



Cable SVGA M/H alta calidad con ferrita

Referencia CABV2x (longitud)
Longitudes 1,8 - 2 - 3 - 5 - 7 - 10
15 - 20 - 25 - 30 - 40 - 50 m.



Adaptadores DisplayPort

AD484 Adaptador DisplayPort M / HDMI tipo A H (A)
AD485 Adaptador DisplayPort M / DVI 24+5 H (B)

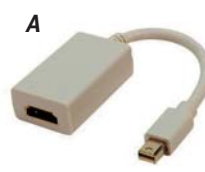

Adaptadores DisplayPort

AD982 Adaptador DisplayPort mini M / HDMI tipo A H (A)
AD983 Adaptador DisplayPort mini M / DVI-I H (B)
AD984 Adaptador DisplayPort mini M / VGA H (C)

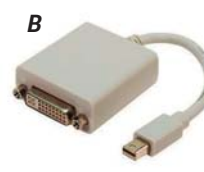

Referencia Descripción
AD460 Adaptador DVI-A 12+5 M / VGA H



Referencia Descripción
AD462 Adaptador DVI-A 24+5 H / VGA M



Referencia Descripción
AD464 Adaptador DVI-D 24+1 H/H



Referencia Descripción
AD465 Adaptador DVI-I 24+5 M/H



Referencia Descripción
AD466 Adaptador DVI-D 24+1 M/H



Referencia Descripción
AD467 Adaptador DVI-I 24+5 H/H



Referencia Descripción
AD468 Adaptador DVI-D 24+1 M / DVI-I 24+5 H

Coaxiales



SERIE BNC



Conectores BNC M recto crimpar 50 Ω

CN1128A	Conector BNC M recto crimpar RG58
CN1128B	Conector BNC M recto crimpar RG59
CN1128C	Conector BNC M recto crimpar RG213
CN1128D	Conector BNC M recto crimpar RG174
CN1128G	Conector BNC M recto crimpar RG6
CN1128H	Conector BNC M recto crimpar RG223
CN1128I	Conector BNC M recto crimpar RG11
CN1128J	Conector BNC M recto crimpar RG214

Conectores BNC M crimpar 75 Ω

CN1129B	Conector BNC M crimpar RG59
CN1129DQ	Conector BNC M crimpar digital 0.8/3.7
CN1129E	Conector BNC M crimpar RG179
CN1129F3	Conector BNC M crimpar Flex 3
CN1129F3.9	Conector BNC M crimpar Flex 3.9
CN1129F5	Conector BNC M crimpar Flex 5
CN1129S12	Conector BNC M crimpar ST212
CN1129S14	Conector BNC M crimpar ST214



Conector BNC macho crimpar rápido

CN1128RG	Conector BNC M recto crimpar RG6 rápido
-----------------	---

Adaptadores BNC 1M/2H

AD5528	Adaptador BNC 1M/2H en T
AD5628	Adaptador BNC 1M/2H en Y

Conector BNC macho soldar

CN8228SC	Conector BNC M recto soldar RG214/RG213
-----------------	---



Conectores BNC M crimpar 90°

CN3129A	Conector BNC M crimpar RG58 90°
CN3129B	Conector BNC M crimpar RG59/ST214 90°
CN3129F2	Conector BNC M crimpar Flex 2 90°
CN3129F3	Conector BNC M crimpar Flex 3 90°
CN3129F5	Conector BNC M crimpar Flex 5 90°

Protectores BNC

PT28Ax	Protector BNC RG58
PT28Bx	Protector BNC RG59
PT28Dx	Protector BNC RG174
Colores disponibles	



Conectores BNC H crimpar 50 Ω

CN1228A	Conector BNC H recto crimpar RG58
CN1228B	Conector BNC H recto crimpar RG59
CN1228C	Conector BNC H recto crimpar RG213
CN1228D	Conector BNC H recto crimpar RG174
CN1228I	Conector BNC H recto crimpar RG11

Conectores BNC H crimpar 75 Ω

CN1229B	Conector BNC H crimpar RG59
CN1229F2	Conector BNC H crimpar Flex 2/RG179
CN1229F3	Conector BNC H crimpar Flex 3
CN1229F5	Conector BNC H crimpar Flex 5
CN1229S12	Conector BNC H crimpar ST212
CN1229S14	Conector BNC H crimpar ST214



Referencia	Descripción
CN2228BA	Conector BNC H panel aislado RG59

Referencia	Descripción
CN1228CI	Conector BNC H C. impreso metalico 90°

Referencia	Descripción
CN2228S	Conector BNC H panel soldar



Adaptadores BNC aéreos

AD1128	Adaptador BNC M/M aéreo
AD1228	Adaptador BNC H/H aéreo

Adaptadores BNC/RCA

AD112849	Adaptador BNC M / RCA M
AD132849	Adaptador BNC M / RCA H
AD142849	Adaptador BNC H / RCA M



Adaptadores BNC H/H panel

AD2228	Adaptador BNC H/H panel 50 Ω
AD2229	Adaptador BNC H/H panel 75 Ω

Adaptadores BNC H/H panel aislado

AD2228A	Adaptador BNC H/H panel aislado 50 Ω
AD2229A	Adaptador BNC H/H panel aislado 75 Ω

SERIE N



Conectores N M crimpar

CN1134A	Conector N M crimpar RG58
CN1134C	Conector N M crimpar RG213/RG214
CN1134H	Conector N M crimpar RG223
CN1134O	Conector N M crimpar LMR240
CN1134P	Conector N M crimpar RG8/LMR400



Conectores N macho soldar

CN1134SA	Conector N M soldar RG58/RG223
CN1134SC	Conector N M soldar RG213/RG214
CN1134SD	Conector N M soldar RG174
CN1134SF	Conector N M clamp 1/2" S/F
CN1134SM1/4"	Conector N M clamp 1/4"
CN1134SP	Conector N M soldar RG8/LMR400



Conectores N M crimpar 90°

CN3134A	Conector N M crimpar RG58 90°
CN3134J	Conector N M crimpar RG214 90°
CN3134P	Conector N M crimpar RG8/LMR400 90°



Conectores N H crimpar

CN1234A	Conector N H crimpar RG58
CN1234B	Conector N H crimpar RG59
CN1234C	Conector N H crimpar RG213
CN1234J	Conector N H crimpar RG214



Conectores N H crimpar panel

CN2234A	Conector N H crimpar RG58 panel
CN2234C	Conector N H crimpar RG213 panel
CN2234H	Conector N H crimpar RG223 panel
CN2234J	Conector N H crimpar RG214 panel



Referencia	Descripción
AD1234	Adaptador N H/H aéreo



Referencia	Descripción
AD2234	Adaptador N H/H panel doble bisel



Referencia	Descripción
AD3334	Adaptador N M/H 90°



Referencia	Descripción
AD7234	Adaptador N H/H panel cuadradillo

SERIE TNC



Conectores TNC macho crimpar

CN1130A	Conector TNC M crimpar RG58
CN1130B	Conector TNC M crimpar RG59
CN1130J	Conector TNC M crimpar RG214



Conectores TNC macho crimpar 90°

CN3130A	Conector TNC M crimpar RG58 90°
CN3130B	Conector TNC M crimpar RG59 90°
CN3130J	Conector TNC M crimpar RG214 90°



Conectores TNC hembra crimpar

CN1230A	Conector TNC H crimpar RG58
CN1230B	Conector TNC H crimpar RG59
CN1230C	Conector TNC H crimpar RG213/RG214



Conectores TNC RP crimpar LMR400

CN1130RPP	Conector TNC M RP crimpar LMR400
CN1230RPP	Conector TNC H RP crimpar LMR400



Referencia	Descripción
CN2230A	Conector TNC H crimpar panel RG58



Referencia	Descripción
AD2230	Adaptador TNC H/H panel

SERIE 7/16



Referencia	Descripción
CN8337J	Conector 7/16 H RG214



Referencia	Descripción
CN8237J	Conector 7/16 M RG214



Referencia	Descripción
AD123734	Adaptador 7/16 H / N H



Referencia	Descripción
AD143734	Adaptador 7/16 H / N M



Referencia	Descripción
AD113734	Adaptador 7/16 M / N M



Referencia	Descripción
AD133734	Adaptador 7/16 M / N H



Referencia	Descripción
AD1237	Adaptador 7/16 H/H



Referencia	Descripción
AD1137	Adaptador 7/16 M/M



Referencia	Descripción
AD3337	Adaptador 7/16 M/H 90°

SERIE 1.6/5.6



Referencia	Descripción
AD2239	Adaptador 1.6/5.6 doble H panel



Referencia	Descripción
AD1139	Adaptador 1.6/5.6 M/M



Puente con toma intermedia

AD39MMH	Puente con toma intermedia 1.6/5.6
AD39MMH25	Puente con toma intermedia 1.6/5.6 atenuado 25 dB



Referencia	Descripción
AD39MMU	Puente sin toma 1.6/5.6 M/M en U



Referencia	Descripción
AD123928	Adaptador 1.6/5.6 H / BNC H



Referencia	Descripción
AD143928	Adaptador 1.6/5.6 H / BNC M



Referencia	Descripción
AD133928	Adaptador 1.6/5.6 M / BNC H



Referencia	Descripción
AD113928	Adaptador 1.6/5.6 M / BNC M



Conectores 1.6/5.6 macho recto crimpar

CN1139F2	Conector 1.6/5.6 M recto crimpar Flex 2/RG179
CN1139F3	Conector 1.6/5.6 M recto crimpar Flex 3
CN1139F5	Conector 1.6/5.6 M recto crimpar Flex 5
CN1139S12	Conector 1.6/5.6 M recto crimpar ST212
CN1139S14	Conector 1.6/5.6 M recto crimpar ST214



Conectores 1.6/5.6 hembra recto crimpar

CN1239F2	Conector 1.6/5.6 H recto crimpar Flex 2/RG179
CN1239F3	Conector 1.6/5.6 H recto crimpar Flex 3
CN1239F5	Conector 1.6/5.6 H recto crimpar Flex 5
CN1239S12	Conector 1.6/5.6 H recto crimpar ST212
CN1239S14	Conector 1.6/5.6 H recto crimpar ST214



Conectores 1.6/5.6 macho S-C 90°

CN3139SF2	Conector 1.6/5.6 M 90° S-C Flex 2/RG179
CN3139SF3	Conector 1.6/5.6 M 90° S-C Flex 3
CN3139SF5	Conector 1.6/5.6 M 90° S-C Flex 5
CN3139S12	Conector 1.6/5.6 M 90° S-C ST212
CN3139S14	Conector 1.6/5.6 M 90° S-C ST214



Conectores 1.6/5.6 hembra S-C 90°

CN3239F2	Conector 1.6/5.6 H 90° S-C Flex 2/RG179
CN3239F3	Conector 1.6/5.6 H 90° S-C Flex 3
CN3239F5	Conector 1.6/5.6 H 90° S-C Flex 5



Conectores 1.6/5.6 macho recto clamp

CN8239SF2	Conector 1.6/5.6 M recto clamp Flex 2
CN8239SF3	Conector 1.6/5.6 M recto clamp Flex 3
CN8239SF5	Conector 1.6/5.6 M recto clamp Flex 5
CN8239SF7	Conector 1.6/5.6 M recto clamp Flex 7
CN8239SS12	Conector 1.6/5.6 M recto clamp ST212



Conectores 1.6/5.6 hembra recto clamp

CN8339SF2	Conector 1.6/5.6 H recto clamp Flex 2
CN8339SF3	Conector 1.6/5.6 H recto clamp Flex 3
CN8339SF5	Conector 1.6/5.6 H recto clamp Flex 5
CN8339SS12	Conector 1.6/5.6 H recto clamp ST212

SERIE 1.0/2.3



Referencia	Descripción
AD1238	Adaptador 1.0/2.3 H/H



Referencia	Descripción
AD38MMH	Puente con toma intermedia



Conector 1.0/2.3 macho recto crimpar

CN1138F2	Conector 1.0/2.3 M recto crimpar Flex 2
CN1138F3	Conector 1.0/2.3 M recto crimpar Flex 3
CN1138F5	Conector 1.0/2.3 M recto crimpar Flex 5
CN1138S12	Conector 1.0/2.3 M recto crimpar ST212



Conector 1.0/2.3 hembra recto crimpar

CN1238F2	Conector 1.0/2.3 H recto crimpar Flex 2
CN1238F3	Conector 1.0/2.3 H recto crimpar Flex 3
CN1238F5	Conector 1.0/2.3 H recto crimpar Flex 5
CN1238S12	Conector 1.0/2.3 H recto crimpar ST212



Conector 1.0/2.3 macho 90° crimpar

CN3138F3	Conector 1.0/2.3 M 90° crimpar Flex 3
CN3138F5	Conector 1.0/2.3 M 90° crimpar Flex 5
CN3138S12	Conector 1.0/2.3 M 90° crimpar ST212
CN3138S14	Conector 1.0/2.3 M 90° crimpar ST214



Conector 1.0/2.3 hembra 90° crimpar

CN3238F3	Conector 1.0/2.3 H 90° crimpar Flex 3
CN3238F5	Conector 1.0/2.3 H 90° crimpar Flex 5

SERIE SMB



Conector SMB pin macho crimpar

CN1120F3	Conector SMB pin M crimpar Flex 3
CN1120F5	Conector SMB pin M crimpar Flex 5
CN1120D	Conector SMB pin M crimpar RG174
CN1120O	Conector SMB pin M crimpar LMR240
CN1120P	Conector SMB pin M crimpar LMR400



Conector SMB pin hembra crimpar

CN1220F3	Conector SMB pin H crimpar Flex 3
CN1220F5	Conector SMB pin H crimpar Flex 5
CN1220D	Conector SMB pin H crimpar RG174/ST212
CN1220O	Conector SMB pin H crimpar LMR240
CN1220P	Conector SMB pin H crimpar LMR400



Conector SMB pin hembra 90° crimpar

CN3220F2	Conector SMB pin H 90° crimpar Flex 2/RG179
CN3220F3	Conector SMB pin H 90° crimpar Flex 3
CN3220F5	Conector SMB pin H 90° crimpar Flex 5
CN3220D	Conector SMB pin H 90° crimpar RG174/ST212



Referencia	Descripción
------------	-------------

CN3120E	Conector SMB pin M 90° crimpar RG179
----------------	--------------------------------------

SERIE SMZ



Conectores SMZ BT43 pin macho crimpar

CN1127F3	Conector SMZ BT43 pin M crimpar Flex 3
CN1127F5	Conector SMZ BT43 pin M crimpar Flex 5



Conectores SMZ BT43 pin hembra crimpar

CN1227F3	Conector SMZ BT43 pin H crimpar Flex 3
CN1227F5	Conector SMZ BT43 pin H crimpar Flex 5



Referencia	Descripción
------------	-------------

AD26MMH	Puente con toma U-Link BT43
----------------	-----------------------------



Referencia	Descripción
------------	-------------

AD26MMU	Puente sin toma BT43
----------------	----------------------

SERIE F / SERIE FME / SERIE PL/UHF

SERIE F



Conector F macho pin crimpar

CN1136B	Conector F M pin crimpar RG59
CN1136F3	Conector F M pin crimpar Flex 3
CN1136G	Conector F M pin crimpar RG6



Conector F macho 90° pin crimpar

CN3136B	Conector F M 90° pin crimpar RG59
CN3136F3	Conector F M 90° pin crimpar Flex 3



Referencia	Descripción
AD2236	Adaptador F H/H panel



Referencia	Descripción
CF75	Carga F 75 Ω

SERIE FME



Referencia	Descripción
CN1150A	Conector FME M crimpar RG58



Referencia	Descripción
CN1250A	Conector FME H crimpar RG58

SERIE PL/UHF



Referencia	Descripción
CN1133A	Conector PL/UHF M crimpar RG58



Referencia	Descripción
AD113634	Adaptador N M / SMA M



Referencia	Descripción
AD143634	Adaptador N M / SMA H



Referencia	Descripción
AD123416	Adaptador N H / SMA H



Referencia	Descripción
AD143416	Adaptador N H / SMA M



Referencia	Descripción
CN1116A	Conector SMA M crimpar RG58/RG223



Referencia	Descripción
CN11160	Conector SMA M crimpar LMR240



Referencia	Descripción
CN1116P	Conector SMA M crimpar LMR400



Referencia	Descripción
CN1117A	Conector SMA M crimpar RG174



Referencia	Descripción
CN3116A	Conector SMA M crimpar RG58/223 90°



Referencia	Descripción
CN1117D	Conector SMA H crimpar RG174



Referencia	Descripción
CN1216A	Conector SMA H crimpar RG58/RG223

SERIE BALUN



Balun 75/120 1.6/5.6 tipo Krone

- BA01K** Balun 75/120 1.6/5.6 H tipo Krone (A)
BA02K Balun 75/120 1.6/5.6 M tipo Krone (B)



Balun 75/120 BNC tipo Krone

- BAB1K** Balun 75/120 BNC H tipo Krone (A)
BAB2K Balun 75/120 BNC M tipo Krone (B)



Balun mini 75/120 1.6/5.6 STP/UTP

- BAM16H** Balun mini 75/120 1.6/5.6 H STP/UTP (A)
BAM16M Balun mini 75/120 1.6/5.6 M STP/UTP (B)



Balun mini 75/120 BNC STP/UTP

- BAMBH** Balun mini 75/120 BNC H STP/UTP (A)
BAMBM Balun mini 75/120 BNC M STP/UTP (B)

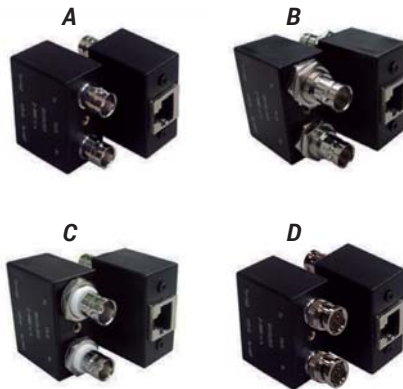

Balun 75/120 doble BNC

- BA2BH** Balun 75/120 doble BNC H (A)
BA2BHP Balun 75/120 doble BNC H panel (B)
BA2BHPA Balun 75/120 doble BNC H panel aislado (C)
BA2BM Balun 75/120 doble BNC M (D)

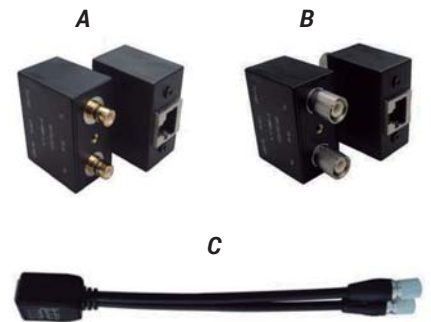

Balun 75/120 doble BNC

- BA216H** Balun 75/120 doble 1.6/5.6 H (A)
BA216M Balun 75/120 doble 1.6/5.6 M (B)
BA216MC Balun 75/120 doble 1.6/5.6 M con cable (C)



- Referencia Descripción**
PAB20161 Panel 19" 1U 20 balun dobles 1.6/5.6



- Referencia Descripción**
PAB20B1 Panel 19" 1U 20 balun dobles BNC



- Referencia Descripción**
PABA24B2 Panel 19" balun 24 RJ49 H / 48 BNC H



- Referencia Descripción**
R161656 Repartidor 16x 1.6/5.6



- Referencia Descripción**
R321023 Repartidor 32x 1.0/2.3



- Referencia Descripción**
BA1BMA Balun sencillo vídeo BNC M (2 piezas)

Electrónica

The background features a complex abstract design. It consists of several sets of thin, parallel blue lines that converge and diverge, creating a sense of depth and movement. These lines are overlaid on larger, semi-transparent blue shapes, including a prominent triangular form on the right side and various curved, wave-like patterns at the bottom. The overall color palette is a range of blues, from light to dark, set against a white background.

CARCASAS SUB-D



Carcasas sub D metálicas

Referencia CSxMTL (pines)
Nº de pines 9 - 15 - 25 - 37

Carcasas sub D metálicas 35° / 45°

Referencia CSxMTL35 (pines)
Nº de pines 9 - 15 - 25 - 37

CS37MTL45 Carcasa sub D 37 metálica 45°

Carcasas sub D metálicas

Referencia CSxMTE (pines)
Nº de pines 9 - 15 - 25 - 50



Carcasas sub D plástico metalizado

CS9MZTC Carcasa sub D 9 plástico metalizado tornillo corto
CS15MZTC Carcasa sub D 15 plástico metalizado tornillo corto
CS15MZTL Carcasa sub D 15 plástico metalizado tornillo largo
CS25MZTC Carcasa sub D 25 plástico metalizado tornillo corto
CS37MZTC Carcasa sub D 37 plástico metalizado tornillo corto
CS50MZTC Carcasa sub D 50 plástico metalizado tornillo corto

Carcasas sub D plástico gris

CS9TCG Carcasa sub D 9 plástico gris tornillo corto
CS15TCG Carcasa sub D 15 plástico gris tornillo corto
CS15TLG Carcasa sub D 15 plástico gris tornillo largo
CS25TCG Carcasa sub D 25 plástico gris tornillo corto



Carcasas libro sub D negras tornillo largo

Referencia CSxLTL (pines)
Nº de pines 9 - 15 - 25

Carcasas sub D plást. negro torn. largo

Referencia CSxTL (pines)
Nº de pines 9 - 15 - 25 - 37

Carcasas adaptadoras sub D plást. gris

CSA909 Carcasa adaptadora sub D 9/9
CSA925 Carcasa adaptadora sub D 9/25
CSA2525 Carcasa adaptadora sub D 25/25



Conectores sub D macho soldar

Referencia CNxMS (pines)
Nº de pines 9 - 15 - 25 - 37 - 50



Conectores sub D hembra soldar

Referencia CNxHS (pines)
Nº de pines 9 - 15 - 25 - 37 - 50



Conectores sub D HD macho soldar

Referencia CNxHDMS (pines)
Nº de pines 15 - 26 - 44 - 62

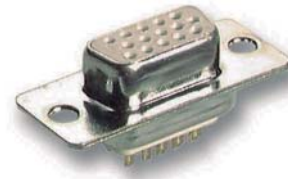

Conectores sub D HD hembra soldar

Referencia CNxHDHS (pines)
Nº de pines 15 - 26 - 62

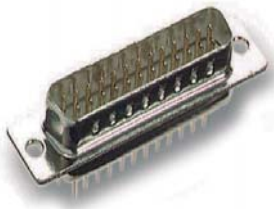

Pin estampado

Conectores sub D macho circuito impreso

Referencia CNxMCI (pines)
Nº de pines 9 - 15 - 25 - 37



Pin estampado

Conectores sub D hembra circuito impreso

Referencia CNxHCI (pines)
Nº de pines 9 - 15 - 25 - 37



Disponibles en bolsas de 100 uds.
y carretes de 1000 uds.



Pin estampado

Cuerpos conectores sub D macho

Referencia CNxMCT (pines)
Nº de pines 9 - 15 - 25 - 37 - 50

Cuerpos conectores sub D hembra

Referencia CNxHCT (pines)
Nº de pines 9 - 15 - 25 - 37 - 50

Carcasas sub D metálicas 35°/45°

CNMCC Pines para conectores macho
CNHCC Pines para conectores hembra

CONECTORES SUB-D



Conectores sub D macho 90° 7.2

Referencia	CNxMCCI (pines)
Nº de pines	9 - 15 - 25



Conectores sub D hembra 90° 7.2

Referencia	CNxHCCI (pines)
Nº de pines	9 - 15 - 25



Con rosca UNC 440

Conectores sub D macho cable plano

Referencia	CNxMPU (pines)
Nº de pines	9 - 15 - 25 - 37



Con rosca UNC 440

Conectores sub D hembra cable plano

Referencia	CNxHPU (pines)
Nº de pines	9 - 15 - 25 - 37



Conectores sub D macho cable plano

Referencia	CNxMP (pines)
Nº de pines	9 - 15 - 25 - 37



Conectores sub D hembra cable plano

Referencia	CNxHP (pines)
Nº de pines	9 - 15 - 25 - 37



Referencia	Descripción
CN15HCCIHD	Conector sub D 15 H 90° paso 9.4 HD



Torretas

T29311	Conjunto torreta UNC 4,40 espárrago 8 mm. (A)
T29313	Torreta doble H UNC 4,40 largo 5 mm. (B)



Brackets

BK77507	Bracket ciego
BK77510	Bracket sub D 9



Conectores Header 2.54 mm. Circuito impreso recto

Referencia	CNHx (vías)
Nº de vías	10 - 14 - 16 - 20 - 26



Conectores Header 2.54 mm. Circuito impreso codó

Referencia	CNHxC (vías)
Nº de vías	10 - 14 - 16 - 20



Conectores Socket 2.54 mm.

Referencia	COSx (vías)
Nº de vías	6 - 8 - 10 - 14 - 16 - 20 - 26 - 34 - 40 - 50 - 64



Jumpers

J33904	Jumper 2.54 abierto (A)
J33907	Jumper 2.54 cerrado (B)



Referencia	Descripción
CN30044	Conector Socket 2 mm. 44 vías



Disponible en rollos de 30,5 o 76,25 m.

Cable plano 1.27 mm.

Referencia	CAPxA (vías)
Nº de vías	10 - 14 - 15 - 16 - 20 - 26 - 34 - 40 - 50 - 60

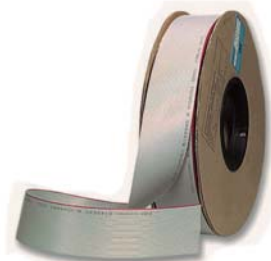

Referencia	Descripción
CAP44B	Cable plano paso 1 mm. 44 vías

CABLES CINTA PLANA



Conectores Telco

CNT50HC	Conector Telco 50 H IDC carcasa codo
CNT50HR	Conector Telco 50 H IDC carcasa recta
CNT50MC	Conector Telco 50 M IDC carcasa codo
CNT50MR	Conector Telco 50 M IDC carcasa recta



Contacto/conector V35

CNV35CH	Contacto V35 hembra
CNV35CM	Contacto V35 macho
CNV35H	Conector V35 hembra
CNV35M	Conector V35 macho



Ferritas redondas

F71501	Ferrita redonda 3,5 mm.
F71502	Ferrita redonda 5 mm.
F71503	Ferrita redonda 7 mm.
F71504	Ferrita redonda 7,5 mm.
F71505	Ferrita redonda 9,5 mm.
F71506	Ferrita redonda 10 mm.
F71507	Ferrita redonda 13 mm.

Ferritas cuadradas

F71508	Ferrita cuadrada 5 mm.
F71509	Ferrita cuadrada 6,5 mm.
F71510	Ferrita cuadrada 10 mm.
F71511	Ferrita cuadrada 13 mm.

Ferritas para cable plano

F71512	Ferrita para cable plano 10 vías
F71513	Ferrita para cable plano 21 vías
F71514	Ferrita para cable plano 26 vías
F71515	Ferrita para cable plano 34 vías



Conector Centronics

CNT50MCM	Conector Centronics 50 vías metal 90°
-----------------	---------------------------------------



Conectores MDR

CNMDR36	Conector MDR 36 pines + carcasa
CNMDR68	Conector MDR 68 pines + carcasa



Conectores RCA

CNRMA	Conector RCA M metálico amarillo
CNRMN	Conector RCA M metálico negro
CNRMR	Conector RCA M metálico rojo
CNRMB	Conector RCA M crimpar RG59
CNRMD	Conector RCA M crimpar RG174



Adaptadores RCA

AD2249	Adaptador 2 RCA H/H panel metálico
AD2249A	Adaptador 2 RCA H/H panel amarillo
AD2249B	Adaptador 2 RCA H/H panel negro
AD2249E	Adaptador 2 RCA H/H panel rojo



Conectores + Contactos MC4

CNMC4M	Conjunto conector + contacto M MC4
CNMC4H	Conjunto conector + contacto H MC4



Conectores mini DIN

CNMDM4	Conector mini DIN M 4 vías
CNMDM6	Conector mini DIN M 6 vías
CNMDM8	Conector mini DIN M 8 vías



Referencia	Descripción
CNXLRM	Conector XLR M aéreo tipo Neutrik 3 contactos negro



Referencia	Descripción
CNXLRH	Conector XLR H aéreo tipo Neutrik 3 contactos negro



Referencia	Descripción
CNSPKM	Conector M tipo Speakon 4 contactos negro



Referencia	Descripción
CNSPKH	Conector H tipo Speakon 4 contactos negro

CABLES DE RED



Schuko M 90° / C13 H gris 3x 0,75/1,00mm.

Referencia CAB501x (longitud)
Longitudes 2 - 2,5 - 3 - 5 m.



Bipolar M / cables con punteras negro 2x 0,75mm.

Referencia CAB502AEx (longitud)
Longitudes 1,8 - 3 - 5 m.



Bipolar M / C7 H negro 2x 0,75mm.

Referencia CAB5021.5
Longitud 1,5 m.



C14 M / C13 H negro 3x 0,75/1,00mm.

Referencia CAB503x (longitud)
Longitudes 0,5 - 1 - 2 - 3 - 5 m.



Schuko M 90° / C13 H negro 3x 1,00mm.

Referencia CAB504x (longitud)
Longitudes 1 - 1,5 - 1,8 - 2 - 3 - 5 m.



C14 M / C13 H gris 3x 0,75/1,00mm.

Referencia CAB507x (longitud)
Longitudes 1 - 3 - 5 m.



Schuko M / C13 H gris 3x 0,75/1,50mm.

Referencia CAB508x (longitud)
Longitudes 2 - 3 - 5 m.



Schuko M / C13 H negro 3x 0,75/1,00mm.

Referencia CAB508Nx (longitud)
Longitudes 2 - 3 - 5 m.



Schuko M / C19 H negro 3x 1,50mm.

Referencia CAB511x (longitud)
Longitudes 1,8 - 3 m.



C20 M / C19 H negro 3x 1,50mm.

Referencia CAB519x (longitud)
Longitudes 1,8 - 2,5 - 5 m.



Schuko M/H negro 3x 1,50mm.

Referencia CAB530x (longitud)
Longitudes 5 - 10 - 15 - 25 m.



C20 M / C13 H negro 3x 1,00mm.

Referencia CAB5311.8
Longitud 1,8 m.



Schuko M / C13 H 90° negro 3x 0,75/1,00mm.

Referencia CAB534x (longitud)
Longitudes 2 - 3 - 5 m.



Schuko M 90° / C13 H 90° negro 3x 0,75/1,00mm.

Referencia CAB535x (longitud)
Longitudes 2 - 3 - 5 m.



Bipolar M / C7 H 90° arriba-abajo negro 2x 0,75mm.

Referencia CAB5462
Longitud 2 m.



Bipolar M / C7 H 90° izquierda-derecha negro 2x 0,75mm.

Referencia CAB5472
Longitud 2 m.



Schuko M 90° / C5 H negro 3x 0,75/1,00mm.

Referencia CAB550x (longitud)
Longitudes 1,8 - 3 - 5 m.



Schuko M 90° / C5 H 90° negro 3x 0,75/1,00mm.

Referencia CAB551x (longitud)
Longitudes 1,8 - 3 - 5 m.



Bipolar M / C7 H blanco 2x 0,75mm.

Referencia CAB589BL1.8
Longitud 1,8 m.



Schuko M 90° / C13 H con seguro 3x 1,00mm.

Referencia CAB600x (longitud)
Longitudes 1 - 2 - 3 m.



C14 M / C13 H con seguro 3x 1mm.

Referencia CAB601x (longitud)
Longitudes 0,5 - 1 - 2 - 3 m.



C20 M / C19 H con seguro 3x 1,50mm.

Referencia CAB607x (longitud)
Longitudes 1 - 2 - 3 m.

CLAVIJAS DE RED



Conectores Schuko macho

CNC05MB	Conector Schuko M blanco
CNC05MN	Conector Schuko M negro

Conectores Schuko macho 90°

CNC05MCB	Conector Schuko M 90° blanco
CNC05MCN	Conector Schuko M 90° negro

Conectores Schuko hembra

CNC05HB	Conector Schuko H blanco
CNC05HN	Conector Schuko H negro



Referencia Descripción

CNC13	Conector IEC C13
--------------	------------------

Referencia Descripción

CNC14	Conector IEC C14
--------------	------------------



Referencia Descripción

CNC19	Conector IEC C19
--------------	------------------

Referencia Descripción

CNC20	Conector IEC C20
--------------	------------------

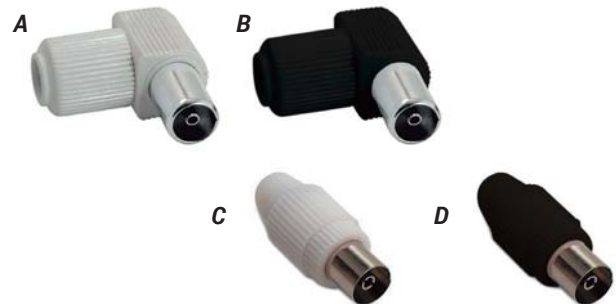
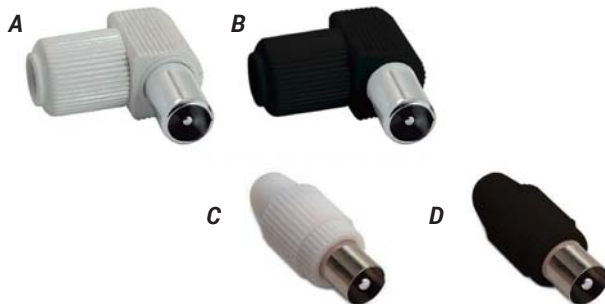

Conectores de antena coaxiales macho

CNTVMCB	Conector de antena coaxial M 90° blindado blanco (A)
CNTVMCN	Conector de antena coaxial M 90° blindado negro (B)
CNTVMRB	Conector de antena coaxial M recto blindado blanco (C)
CNTVMRN	Conector de antena coaxial M recto blindado negro (D)

Conectores de antena coaxiales hembra

CNTVHCB	Conector de antena coaxial H 90° blindado blanco (A)
CNTVHCN	Conector de antena coaxial H 90° blindado negro (B)
CNTVHRB	Conector de antena coaxial H recto blindado blanco (C)
CNTVHRN	Conector de antena coaxial H recto blindado negro (D)

